

## Выкройка рюкзака



Материал: Кожа растительного дубления, толщина 1,8-2мм

Нить вошенная – 0,8мм

Отверстия под шов – 1мм с шагом 5мм (на некоторых участках скругления шаг плавает от 4,85 до 5,1 мм, поэтому бил все одиночным пробойником).

Размер: Высота x Ширина x Глубина – 24см x 20см x 8см



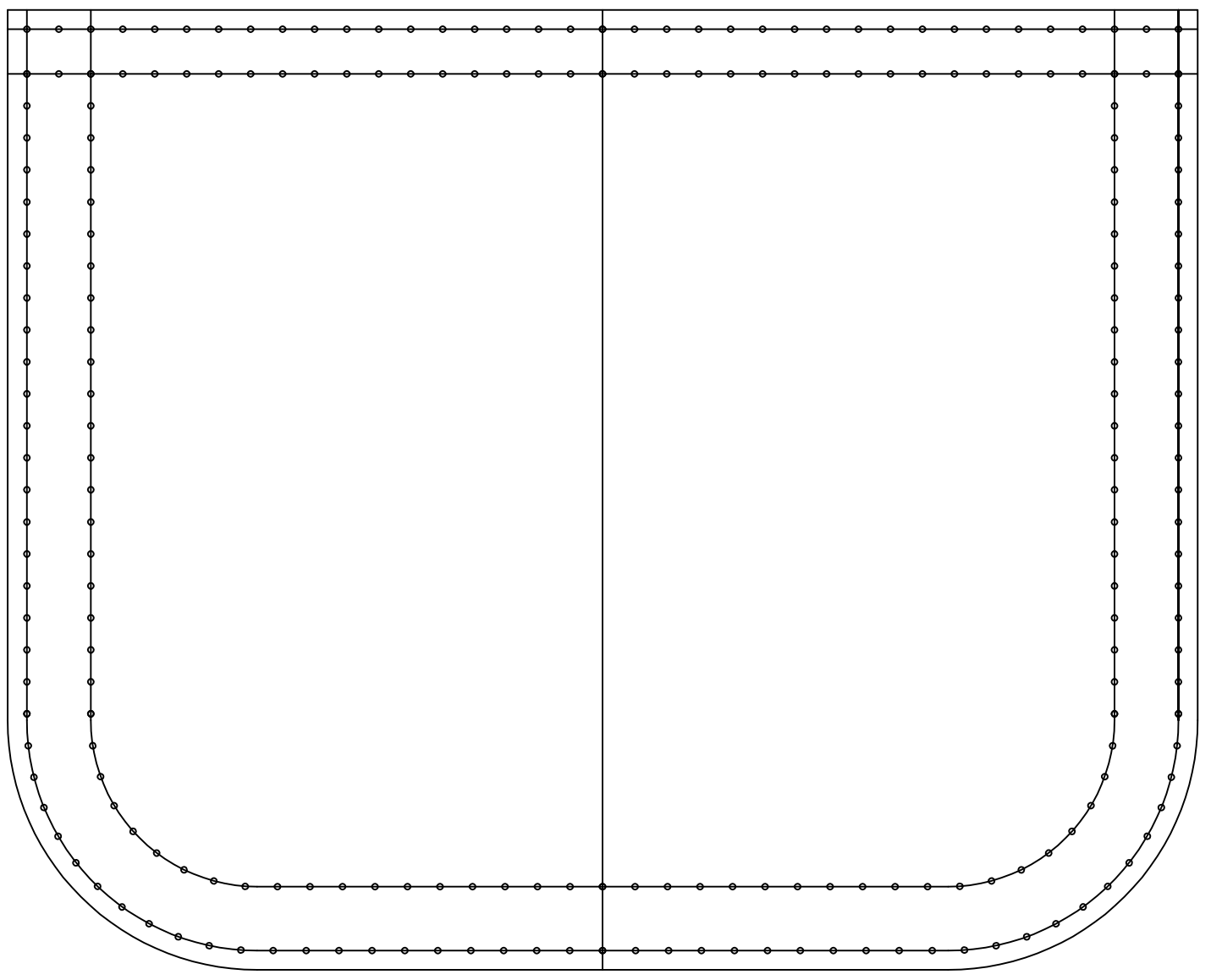
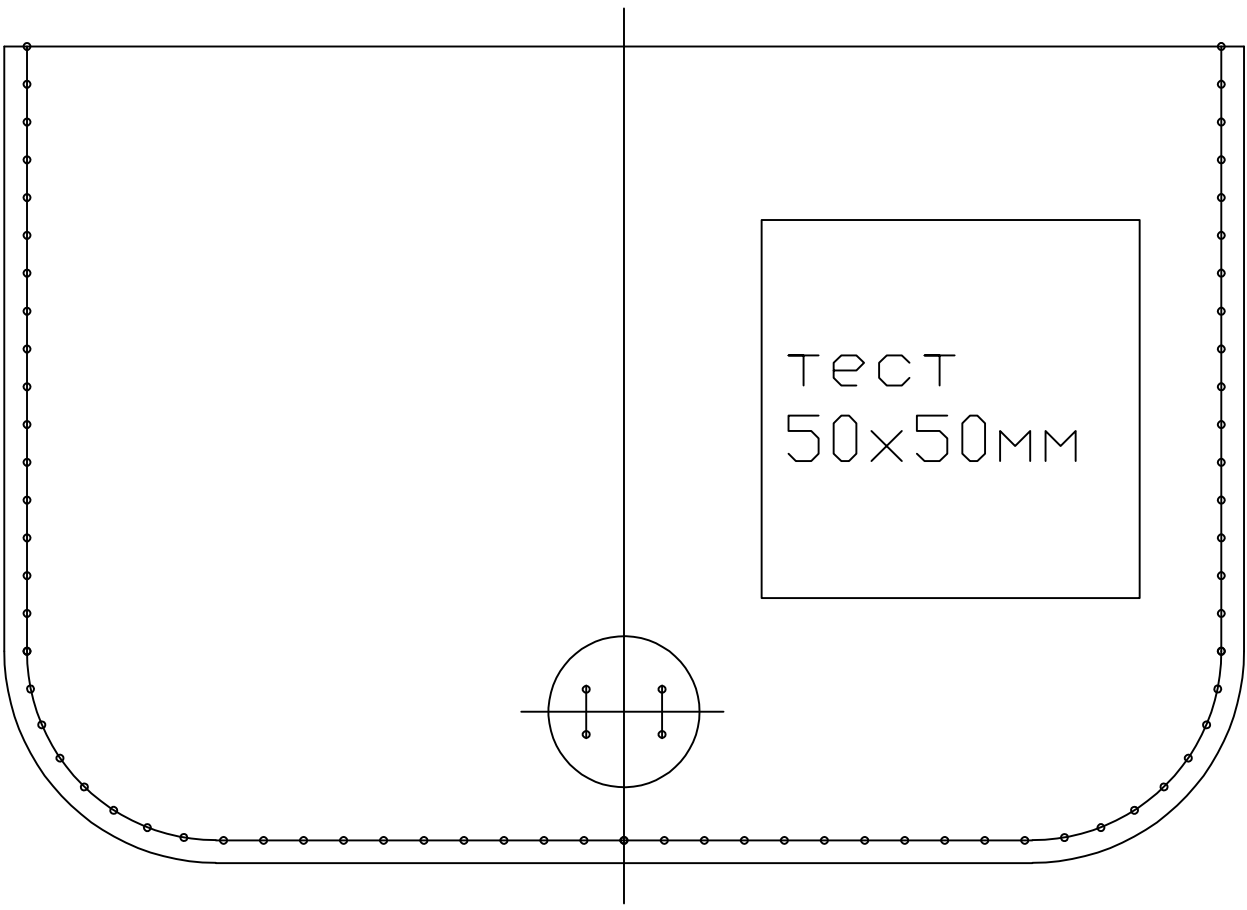

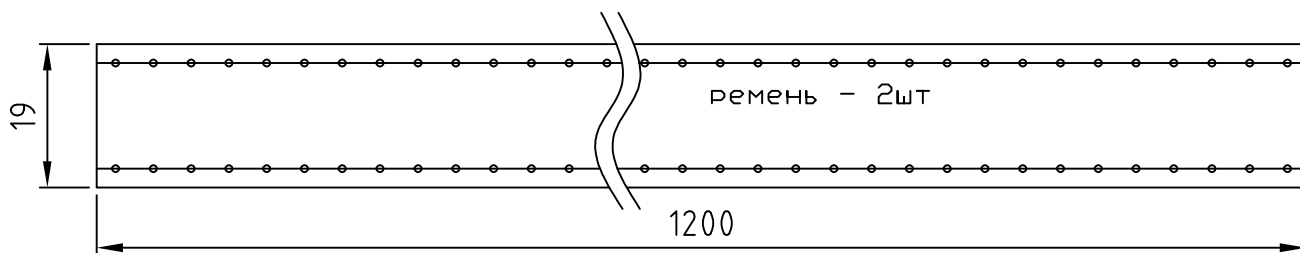
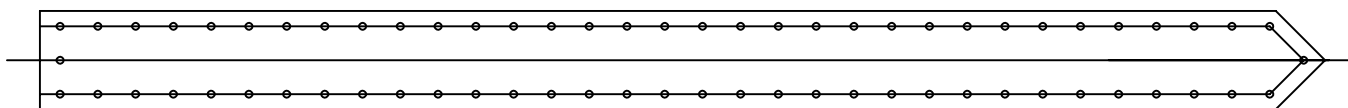
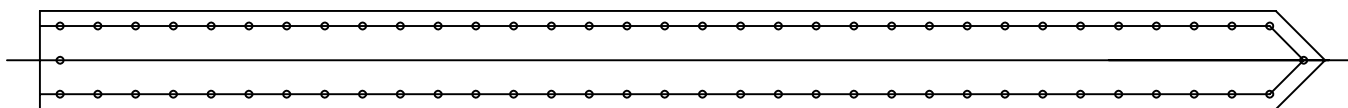
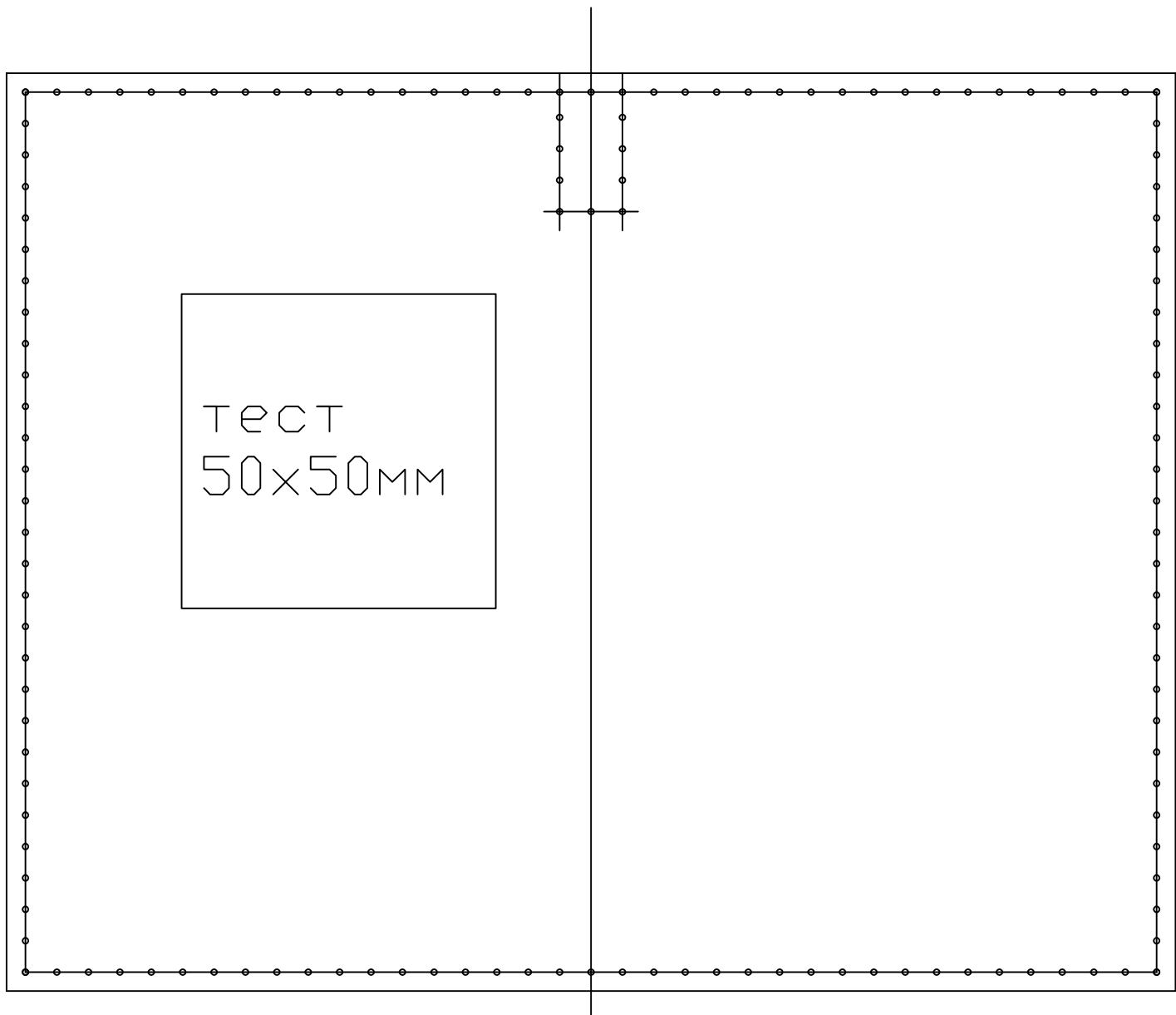

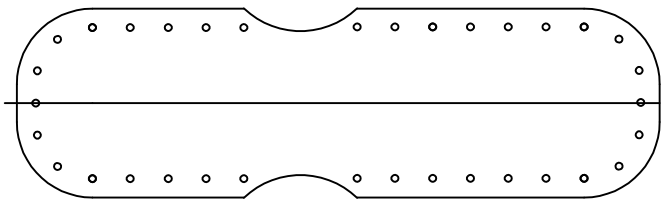
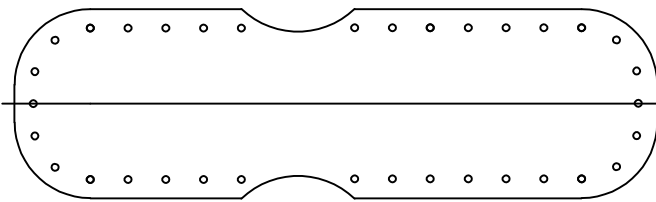
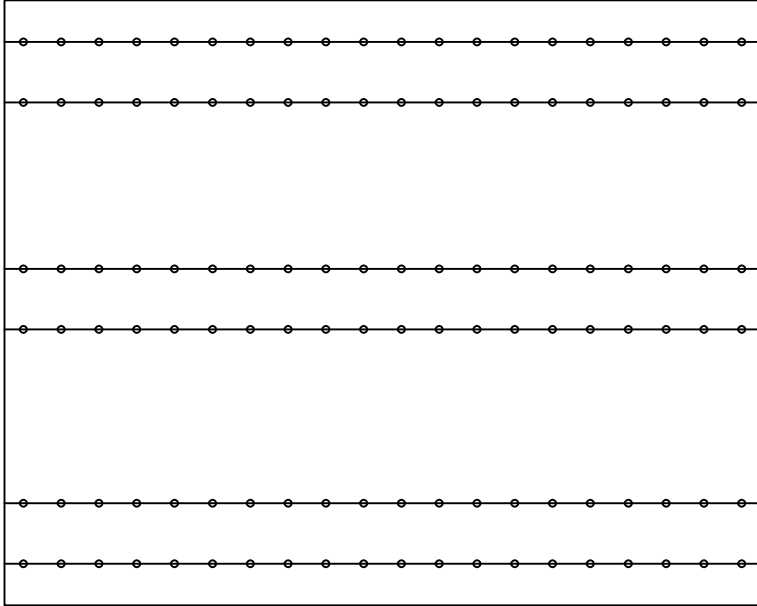
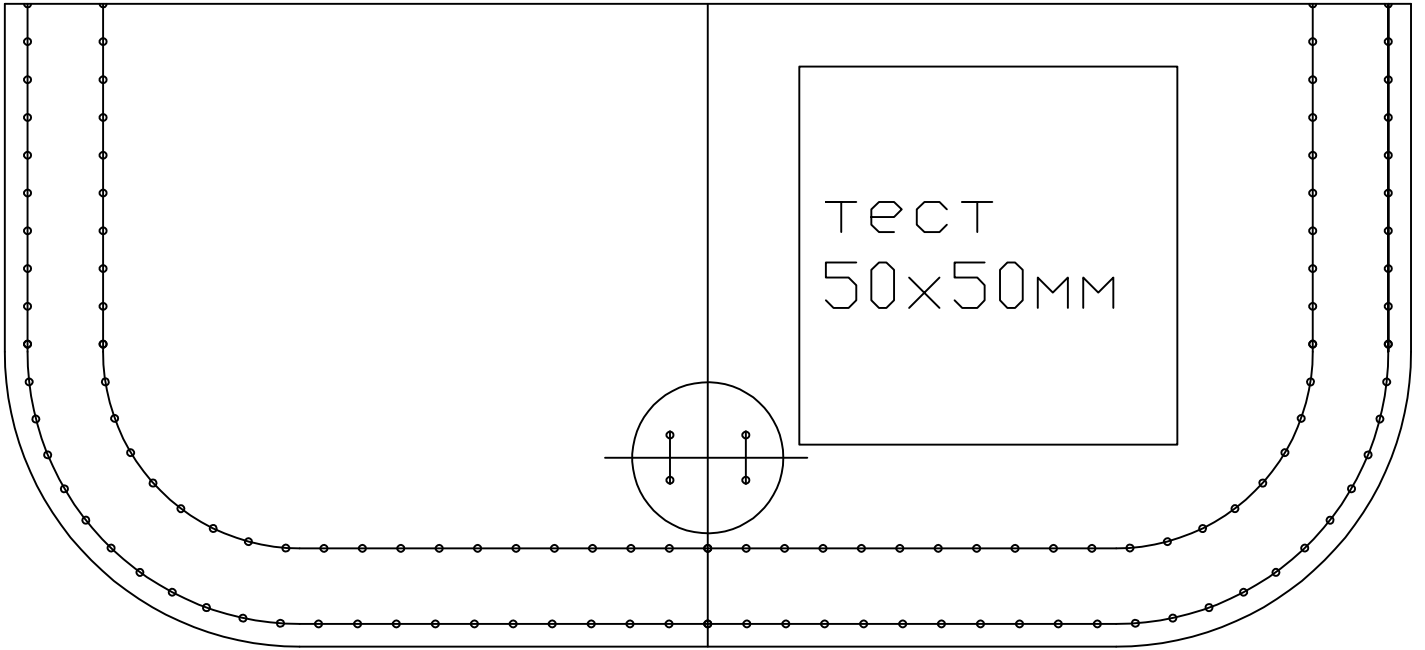

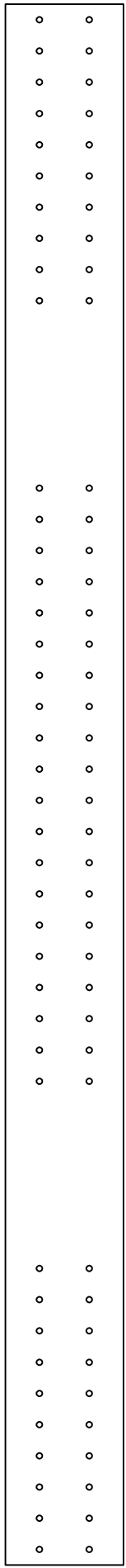
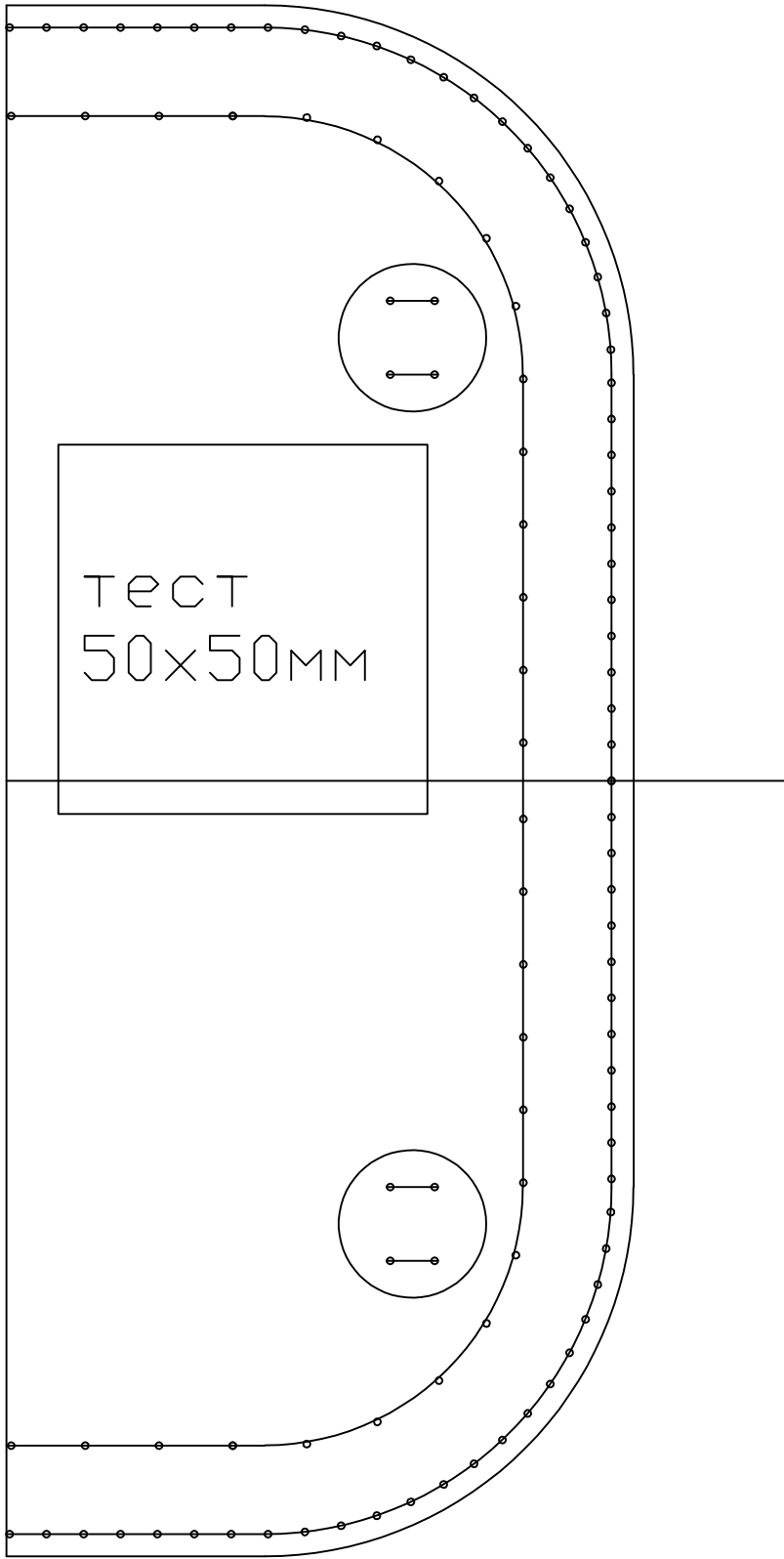

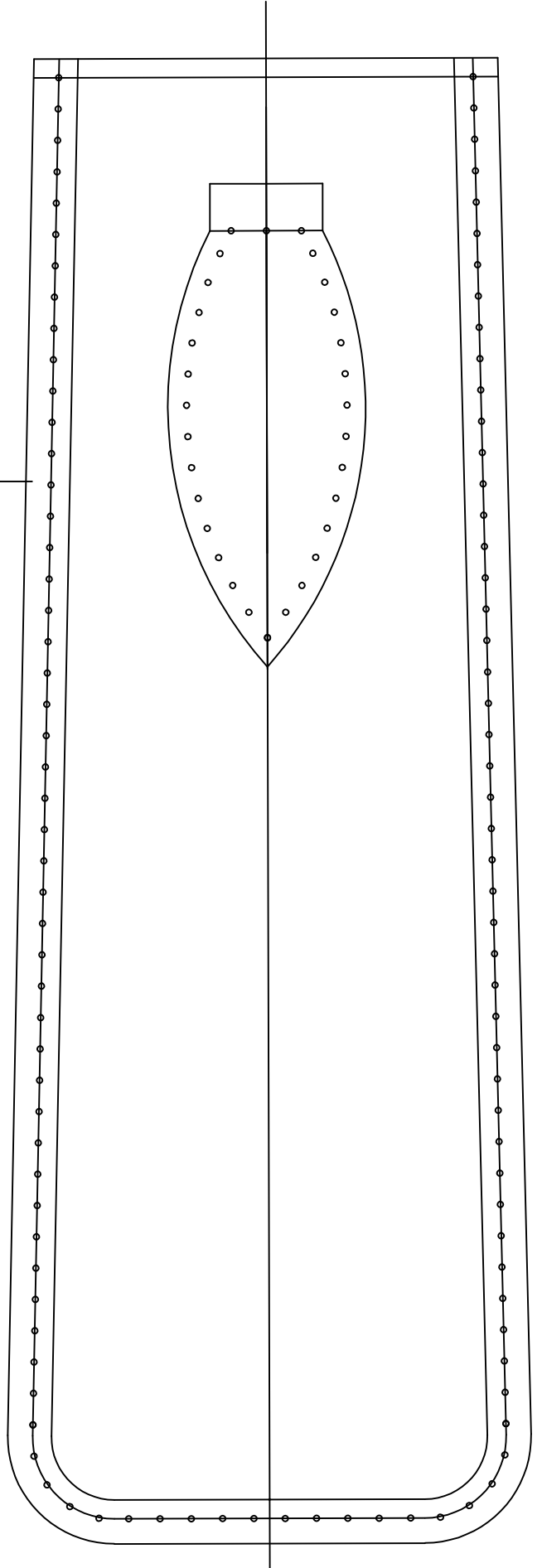
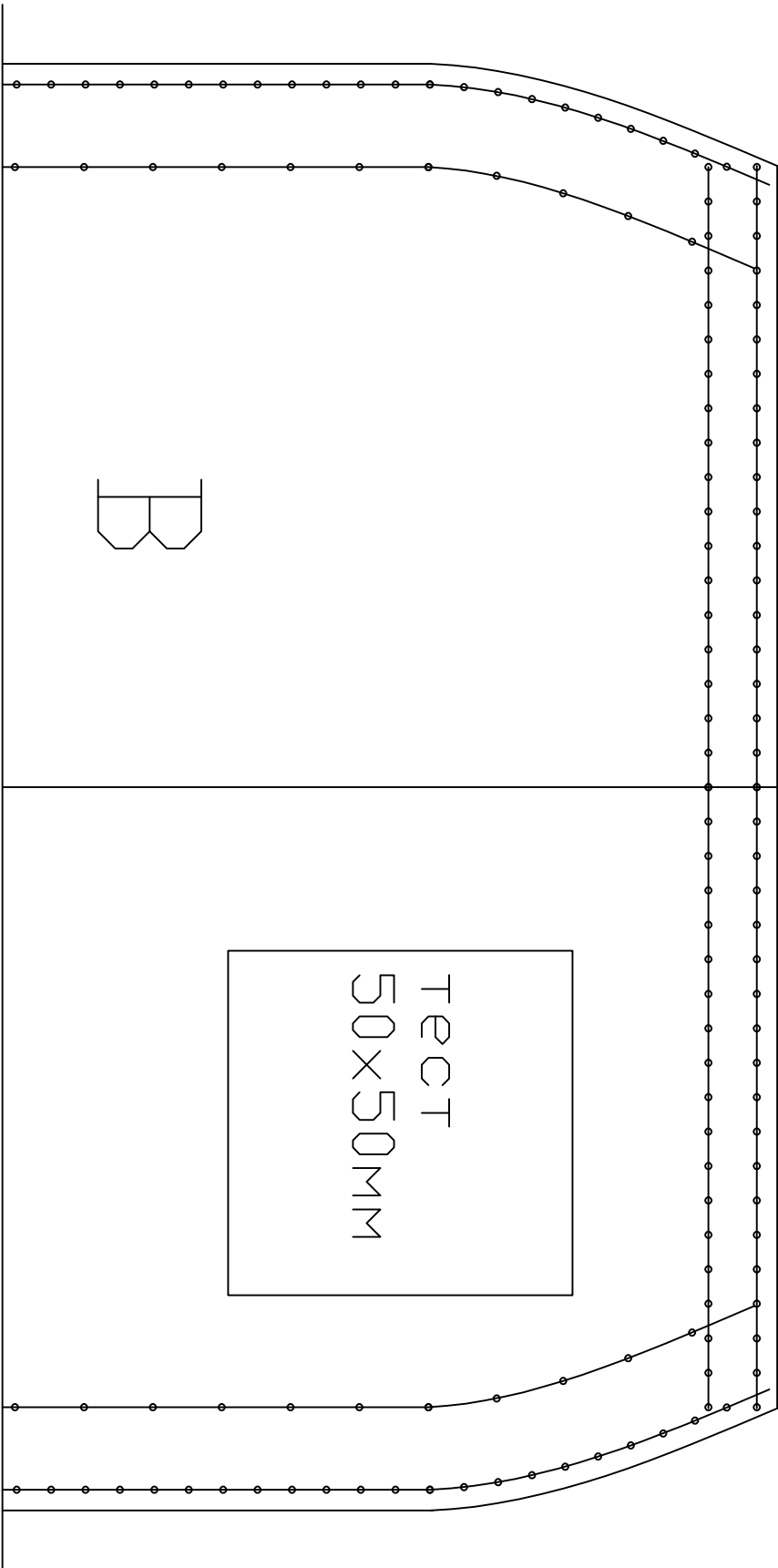

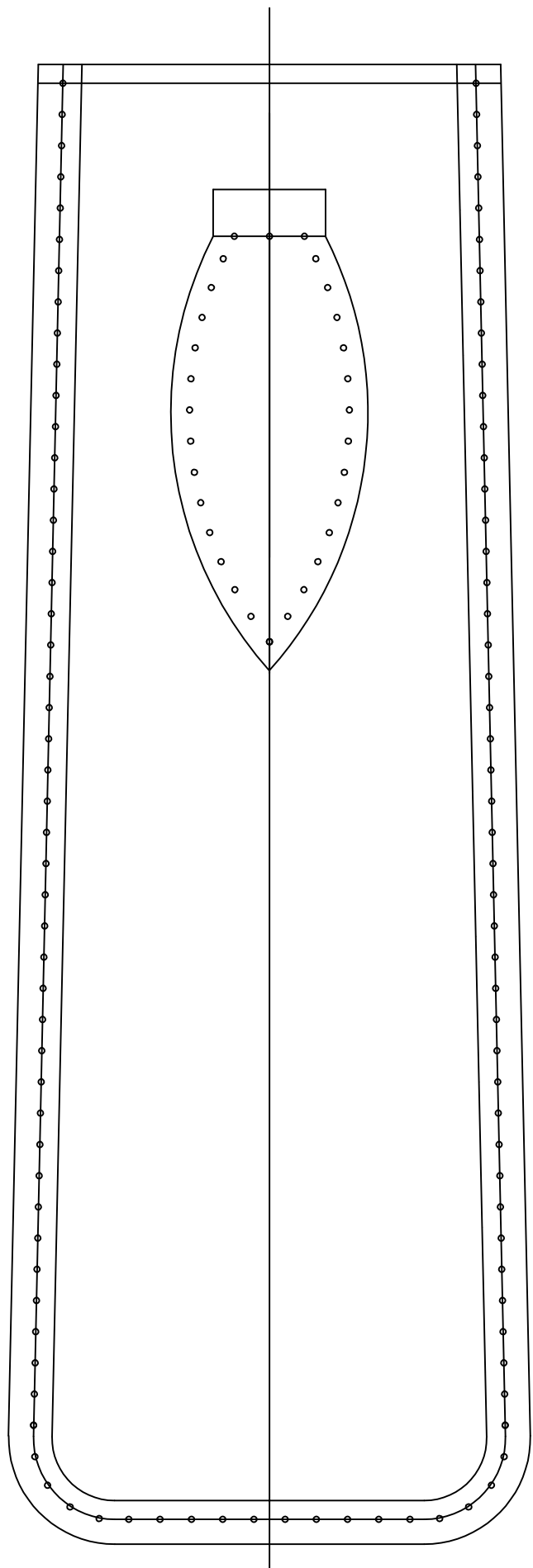
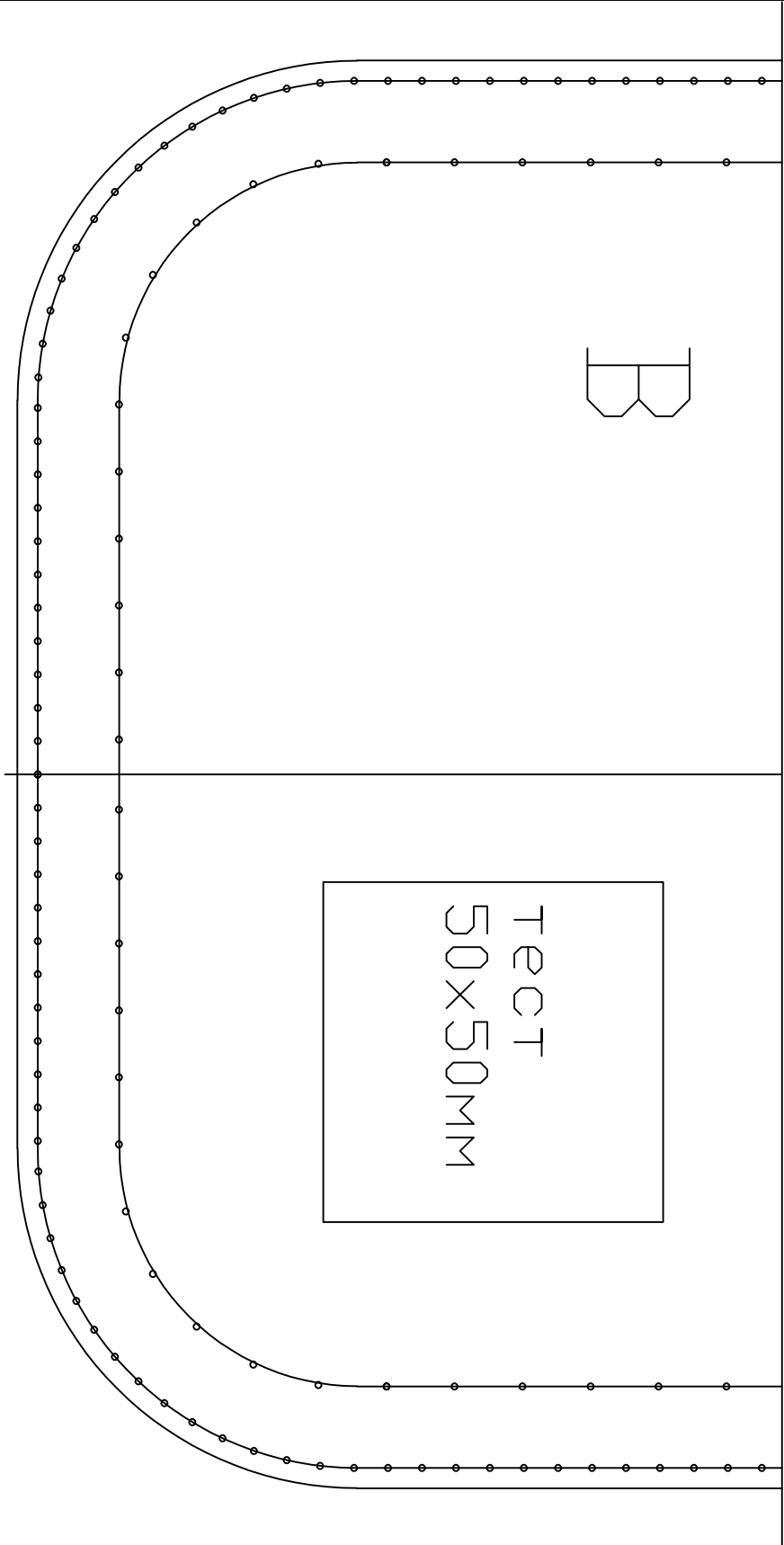



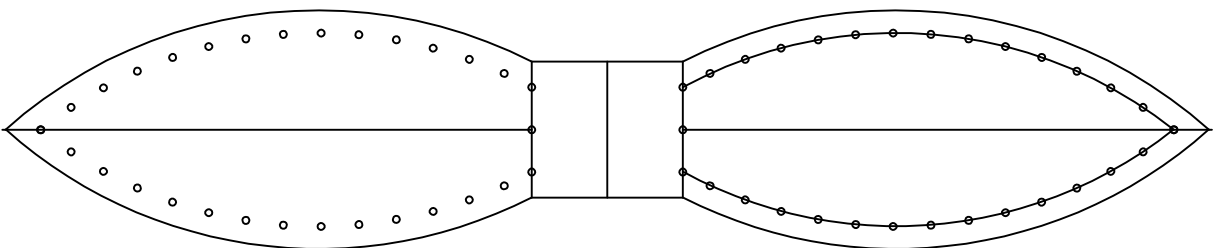
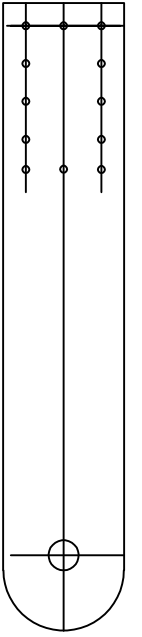
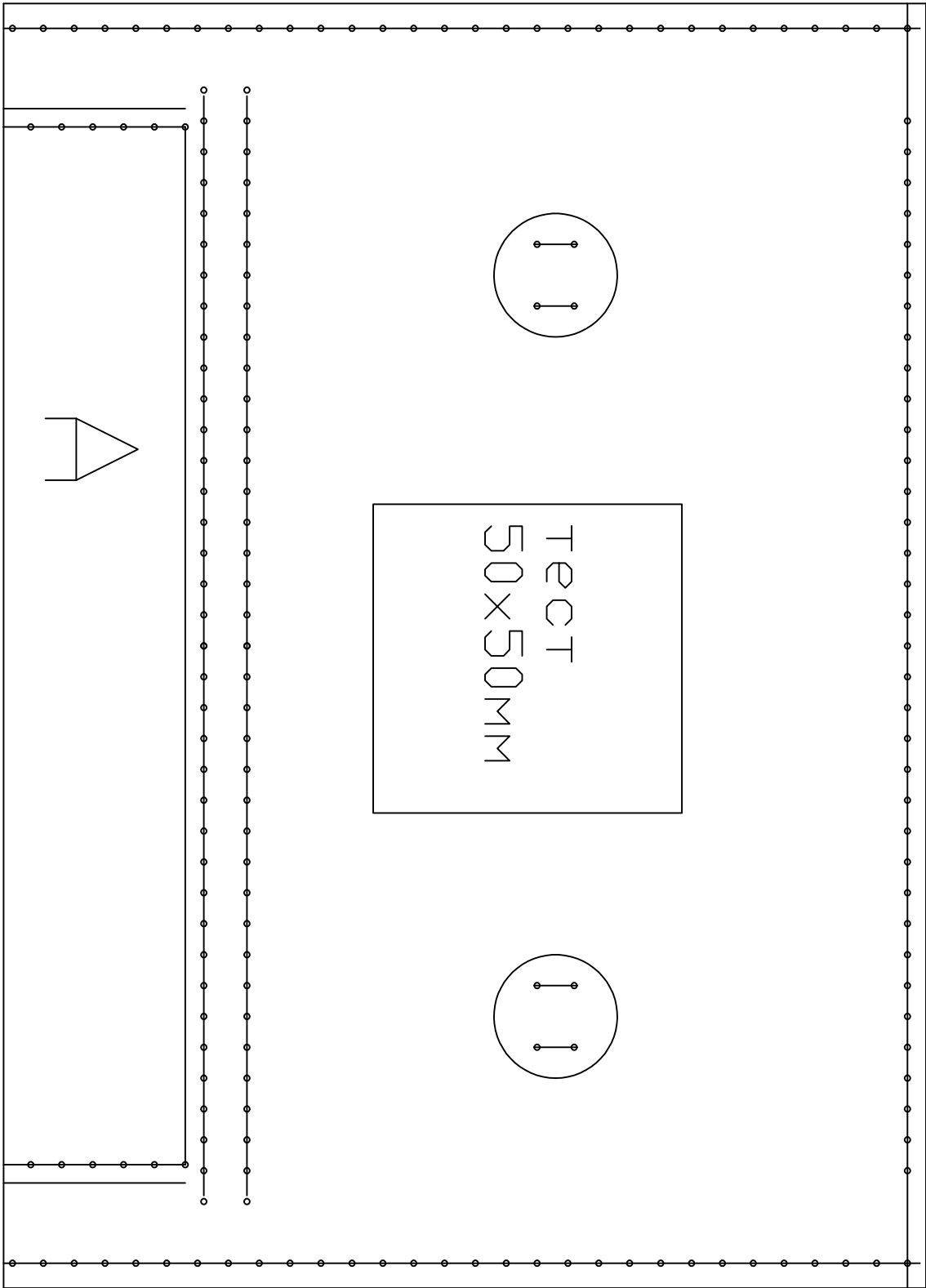

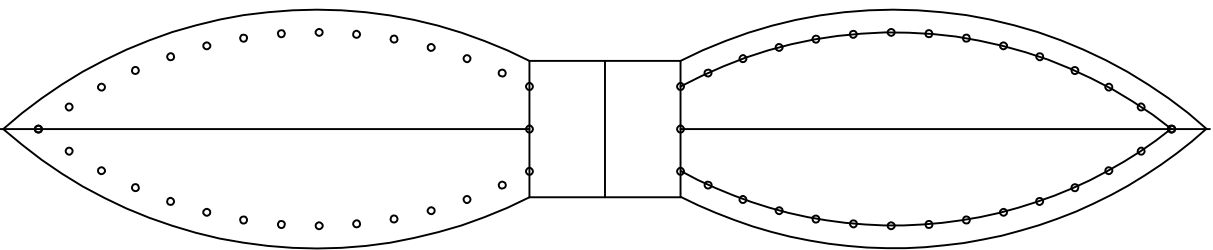
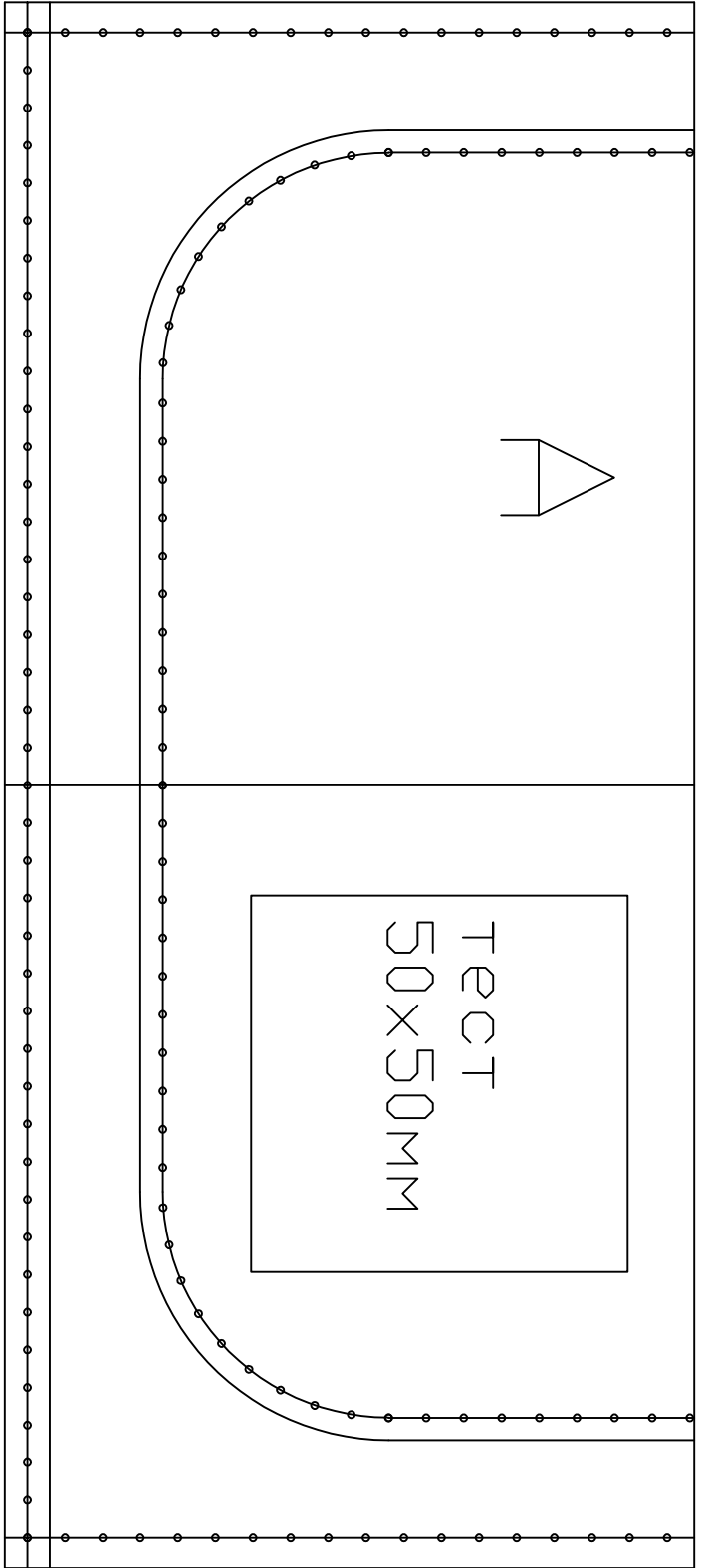
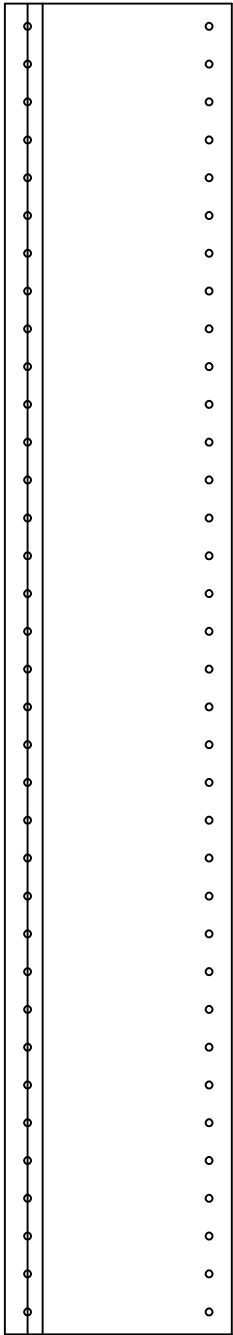
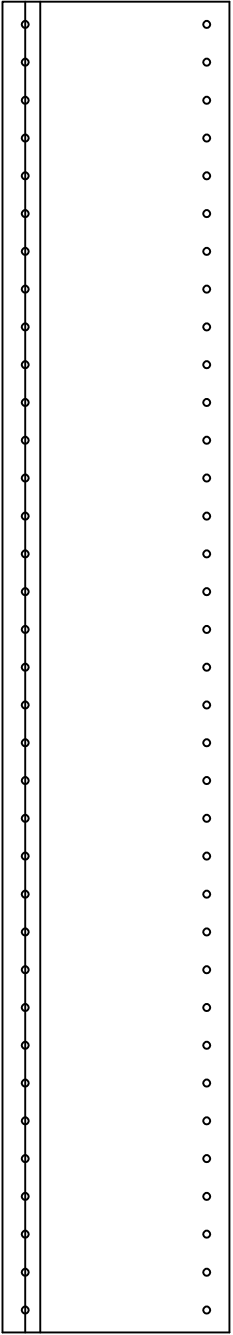

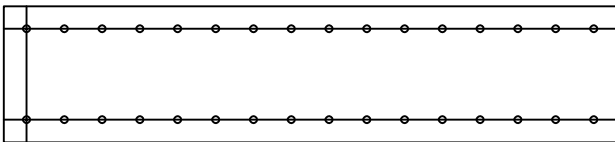
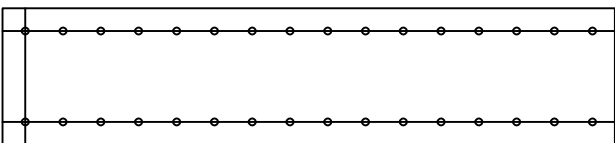
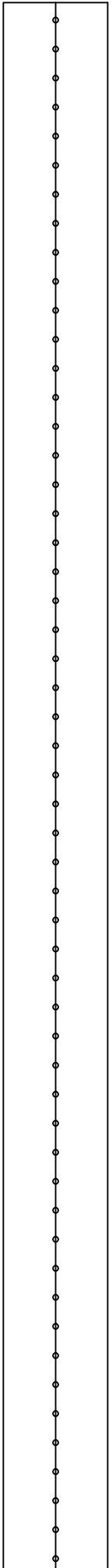
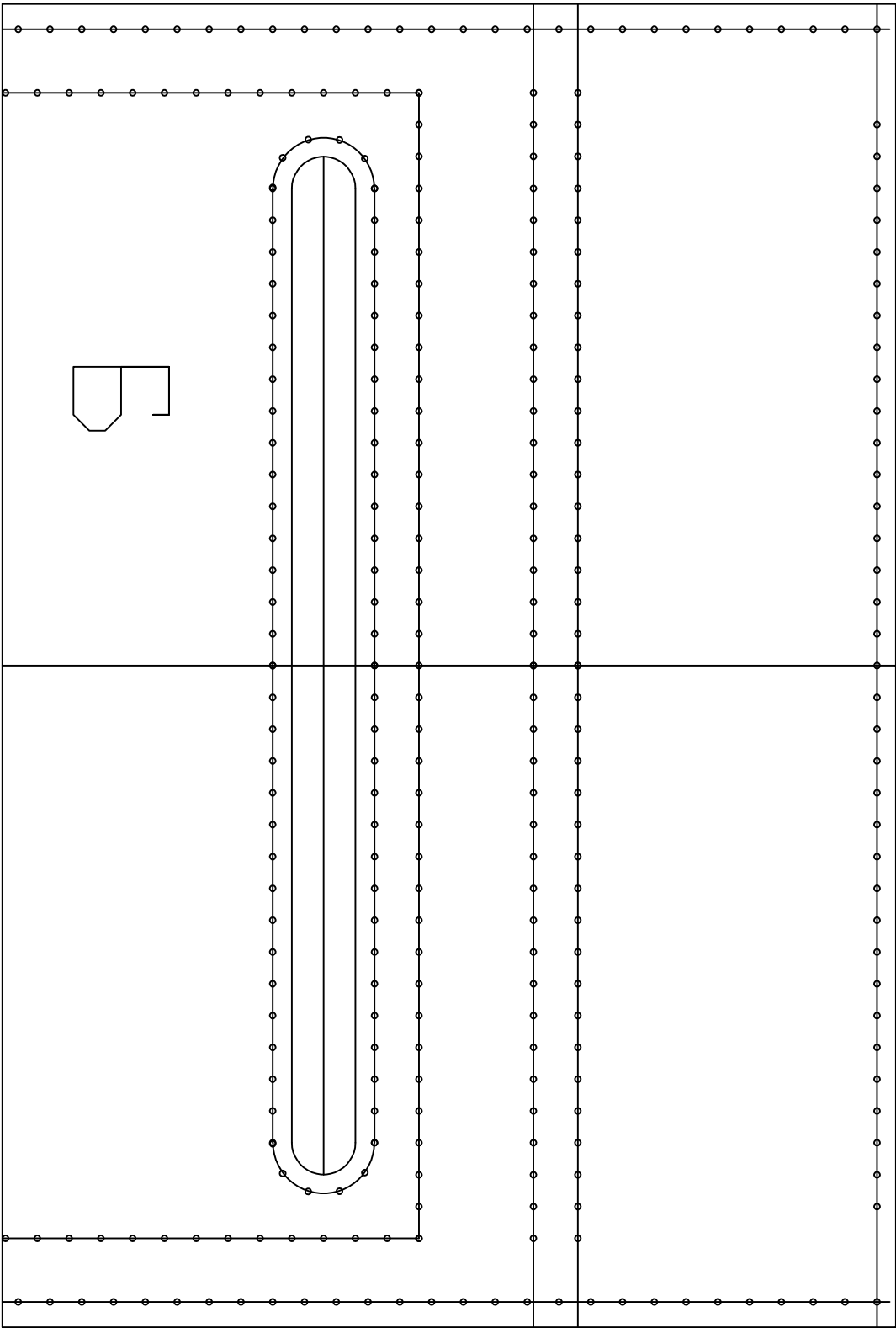

TECT  
50X50MM

