

80

Test scale, 80mm

256

5

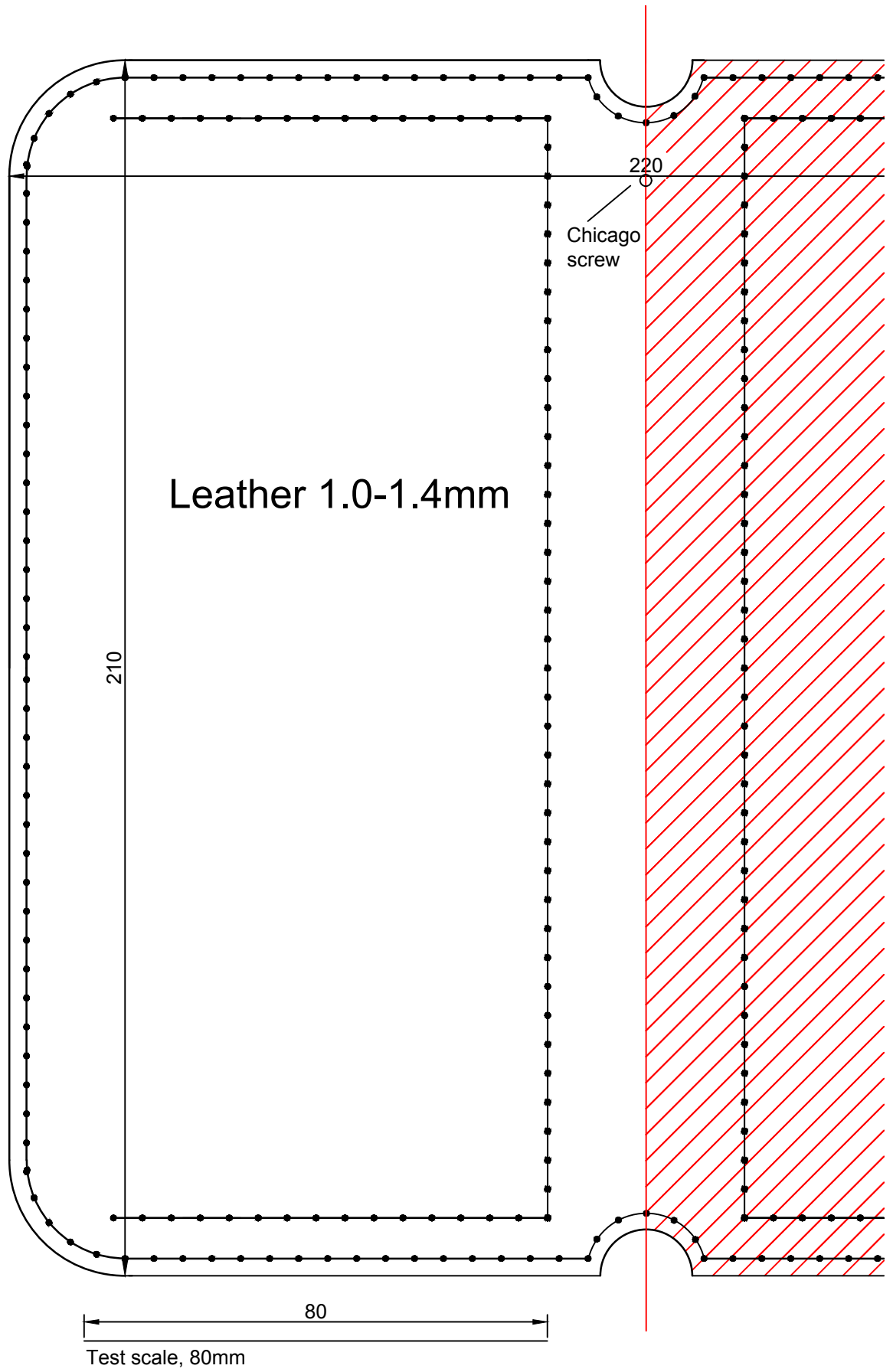

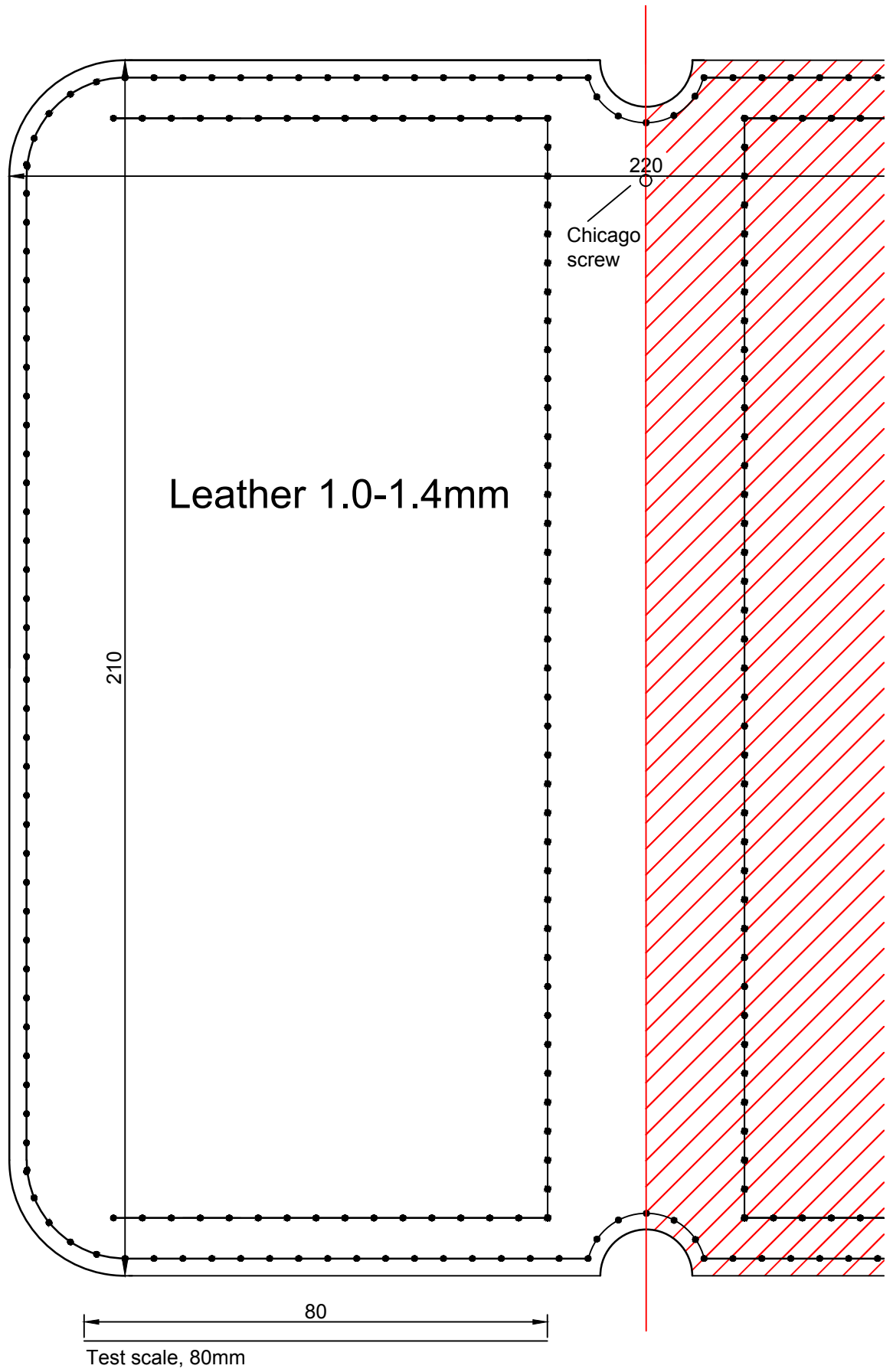

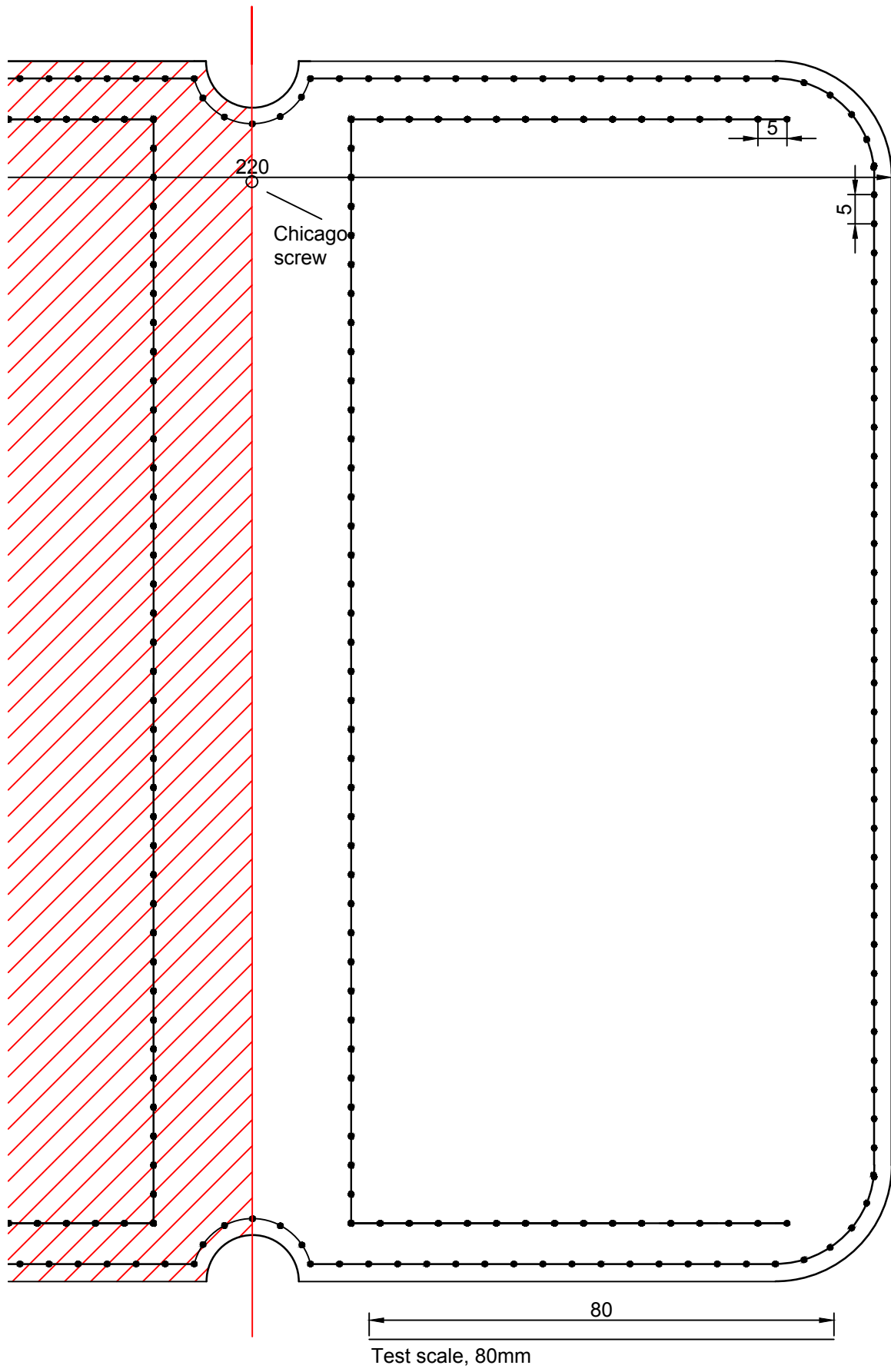

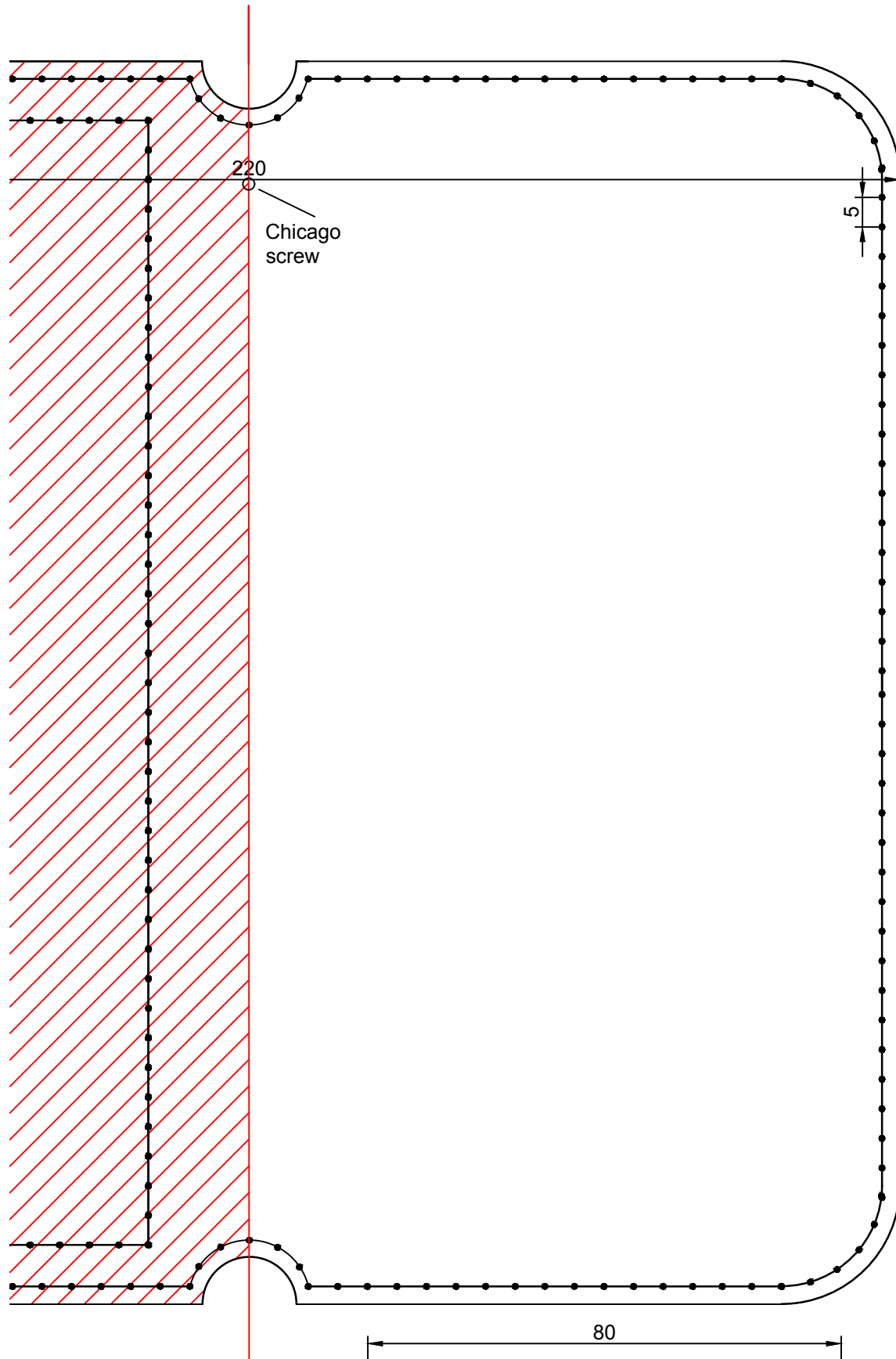

220

Chicago screw

5

80

Test scale, 80mm

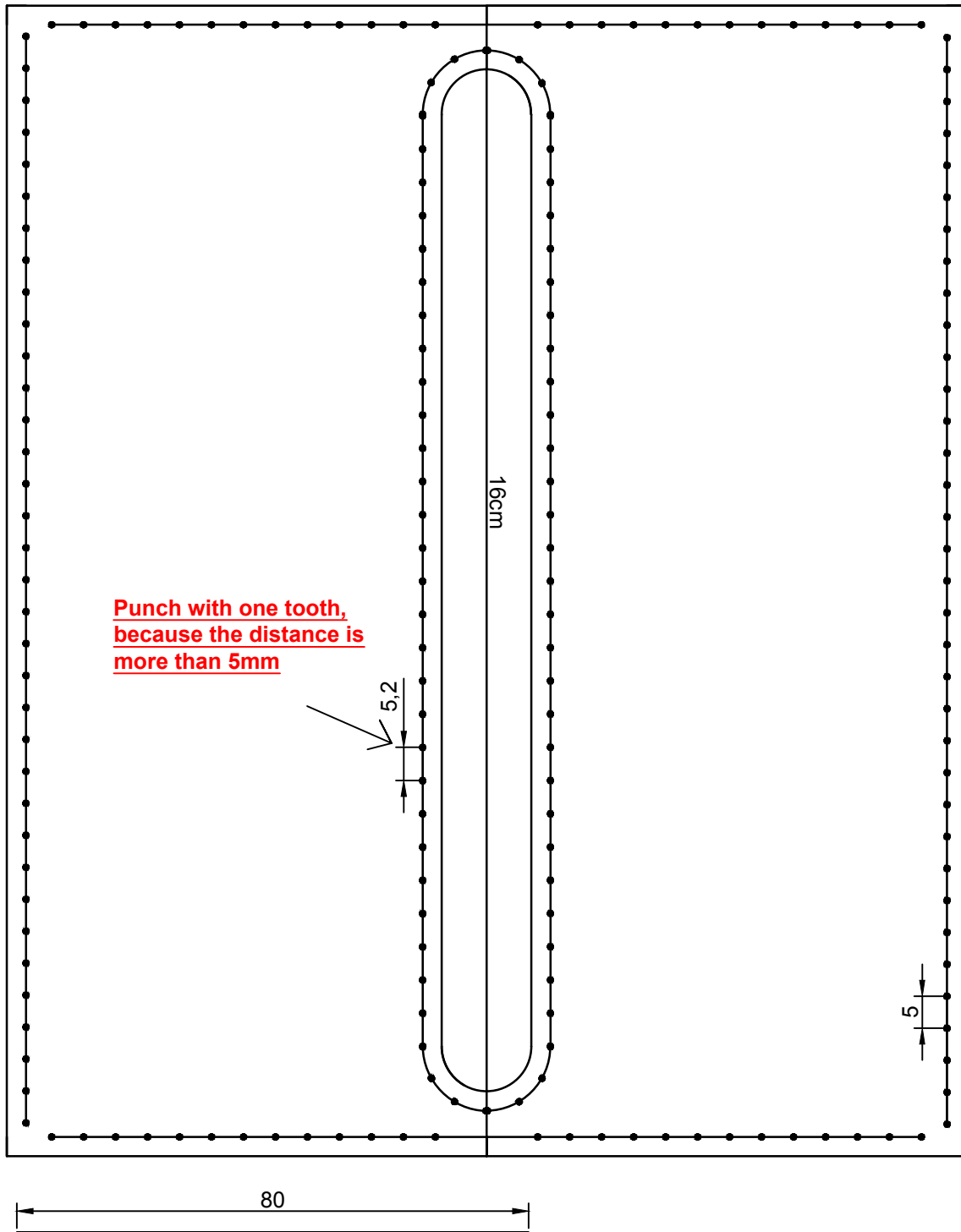

Test scale, 80mm

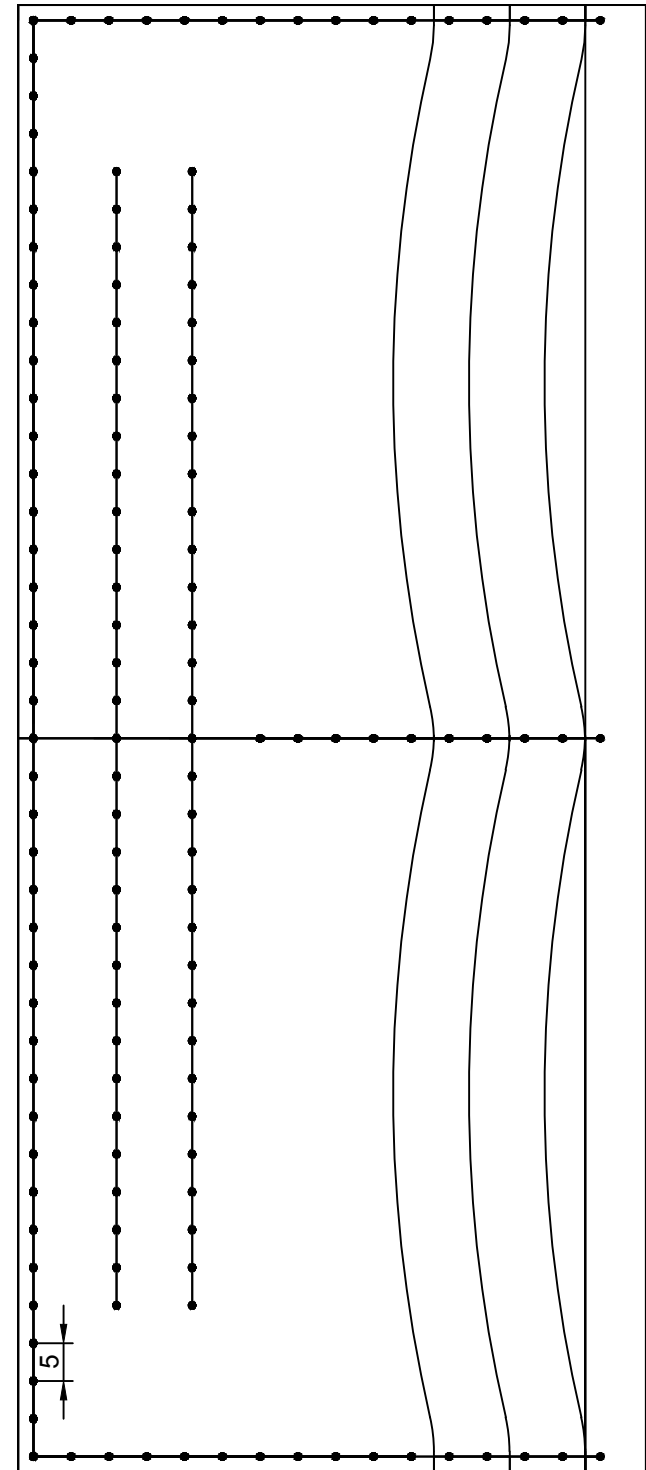

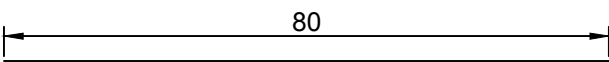
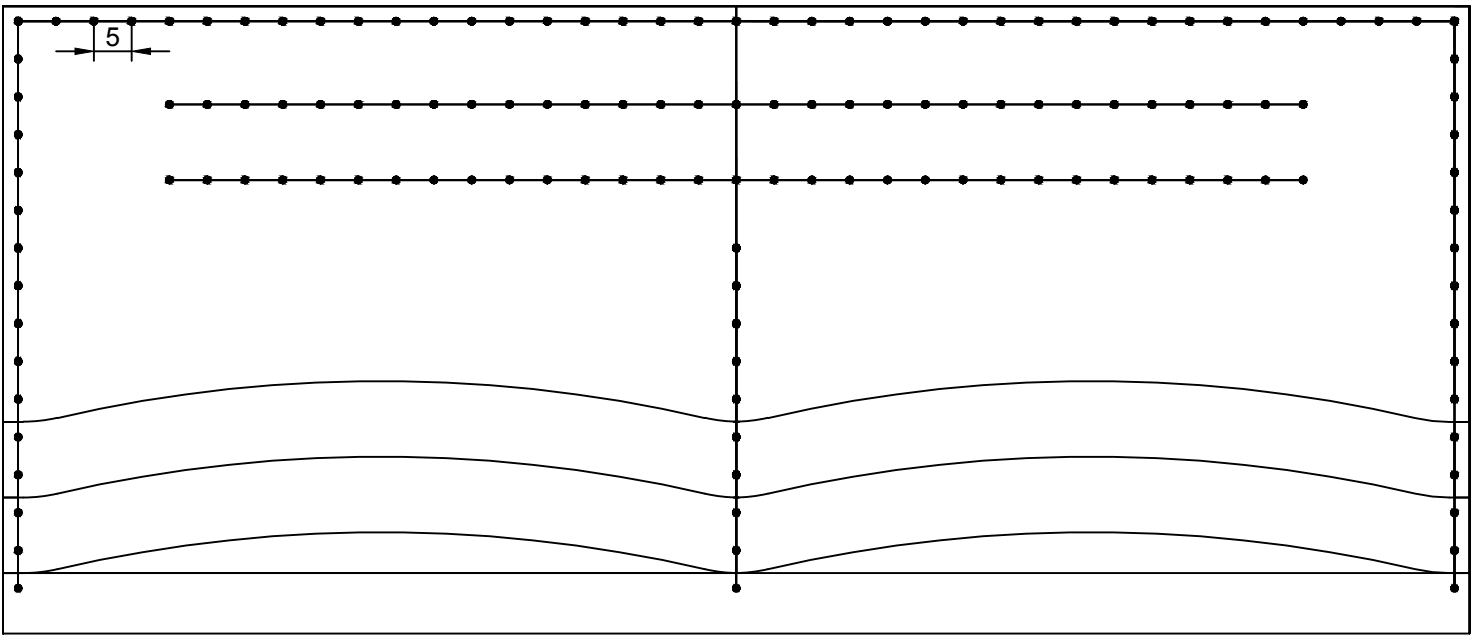
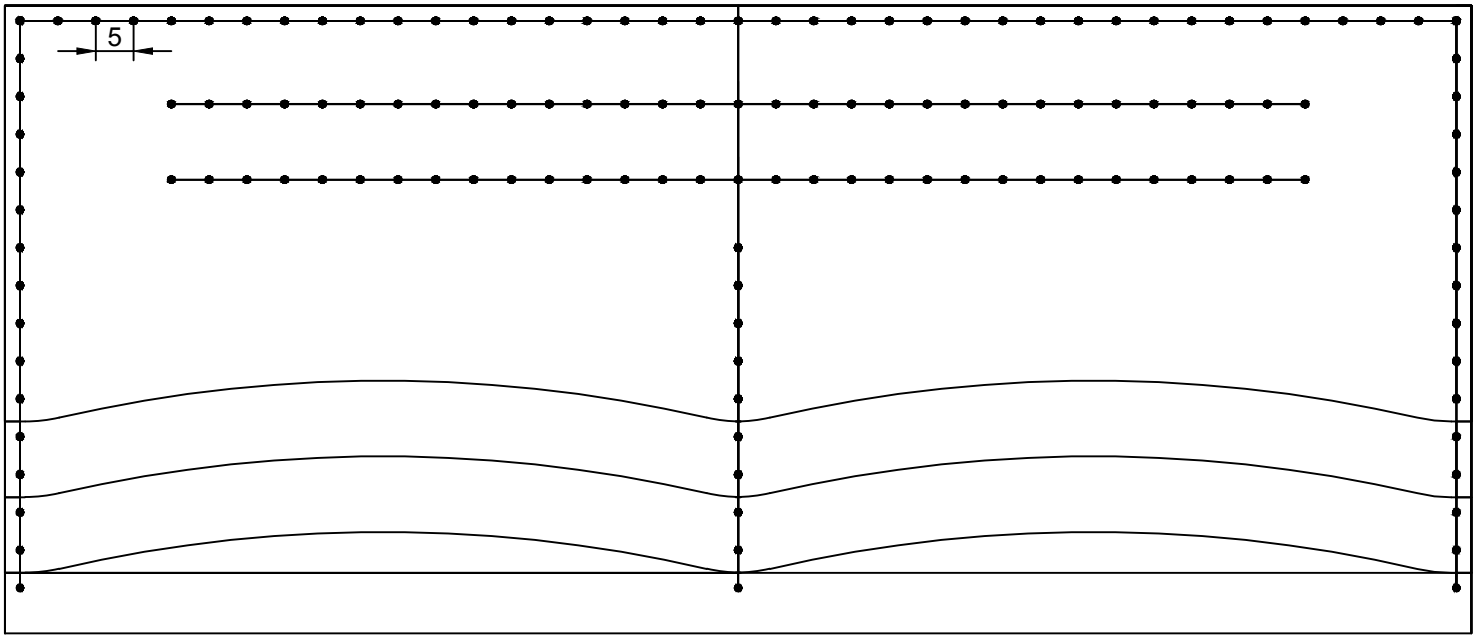

Test scale, 80mm



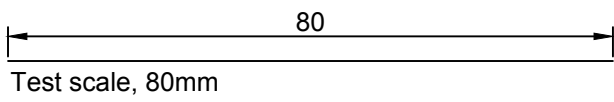
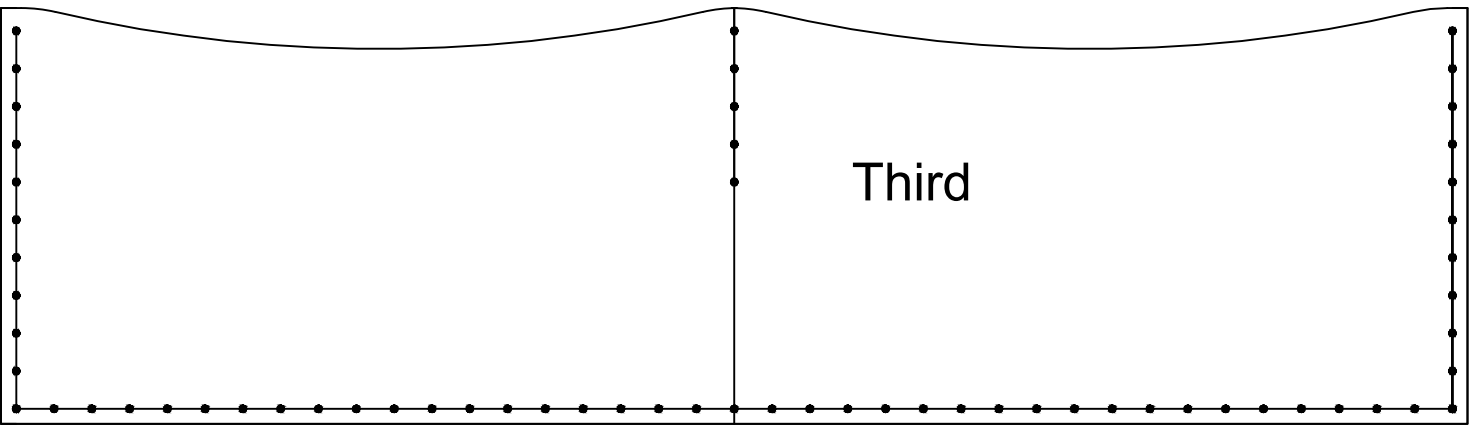
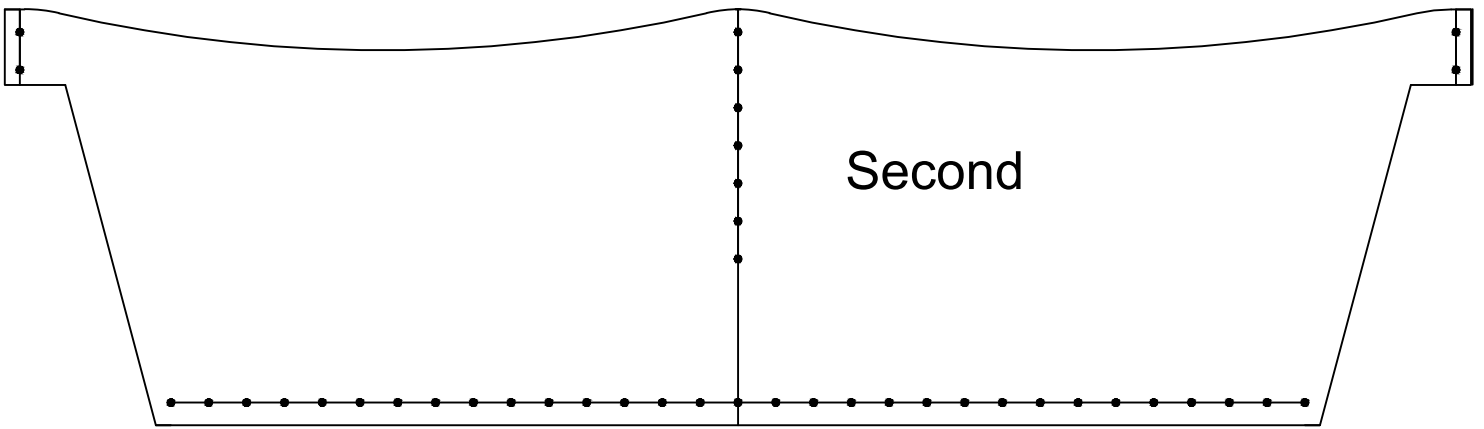
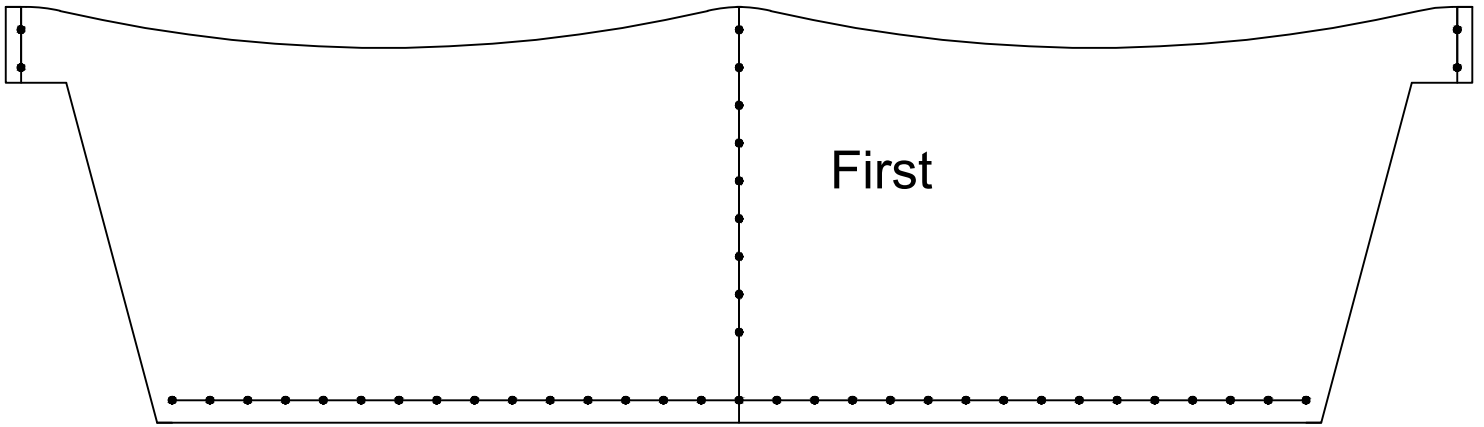

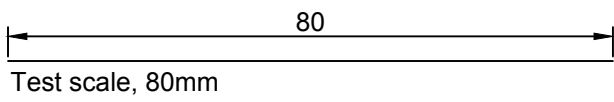
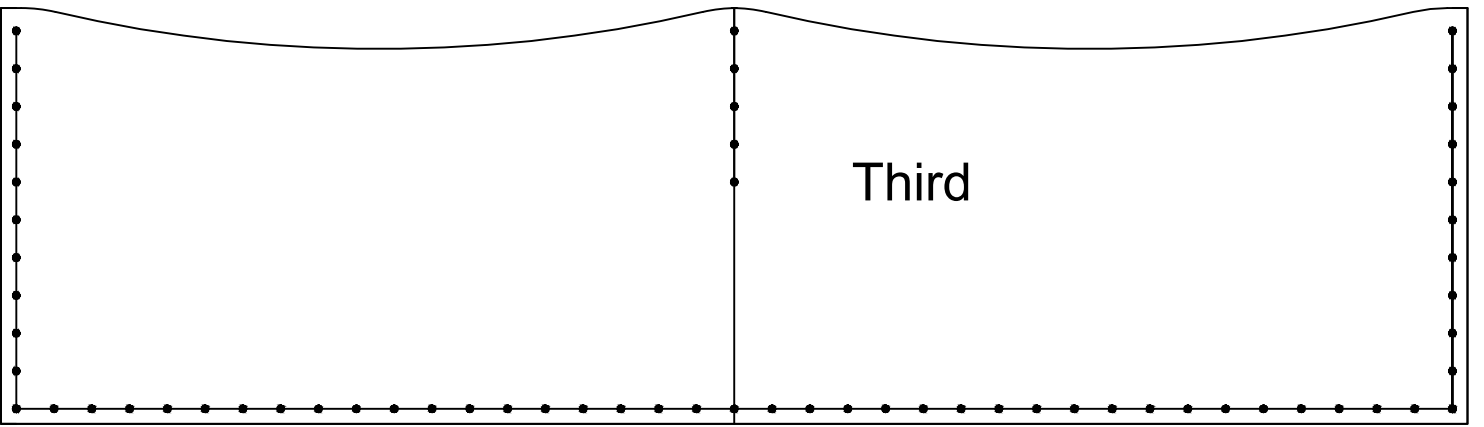
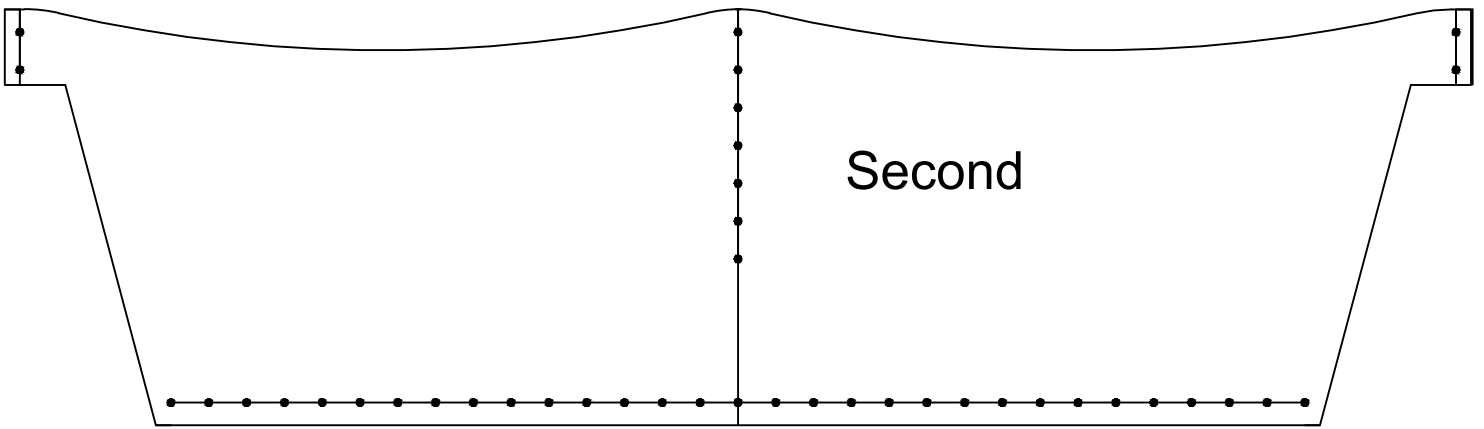
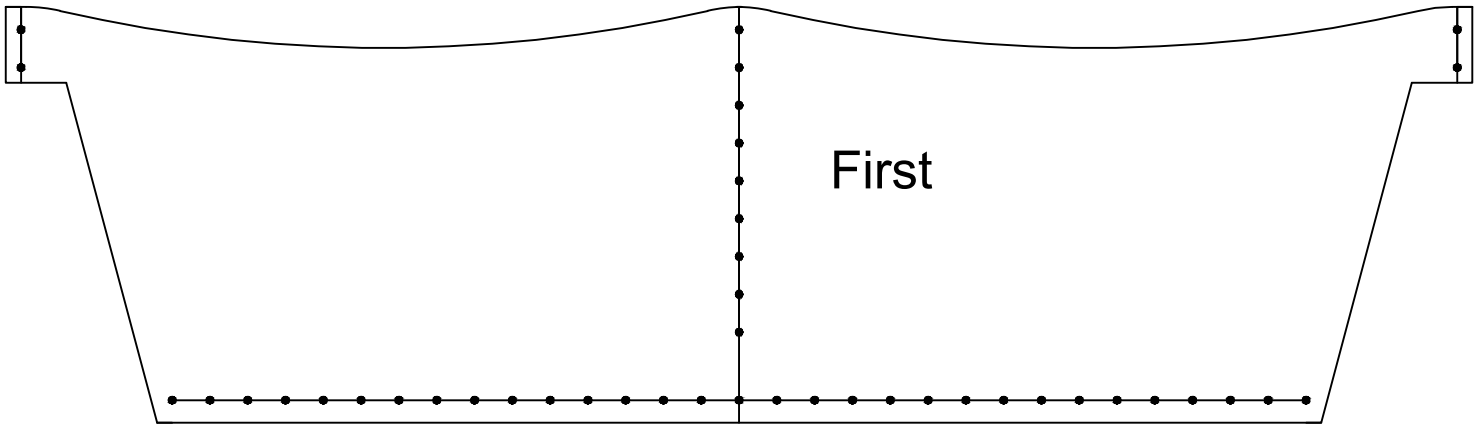

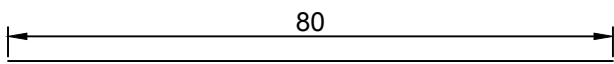
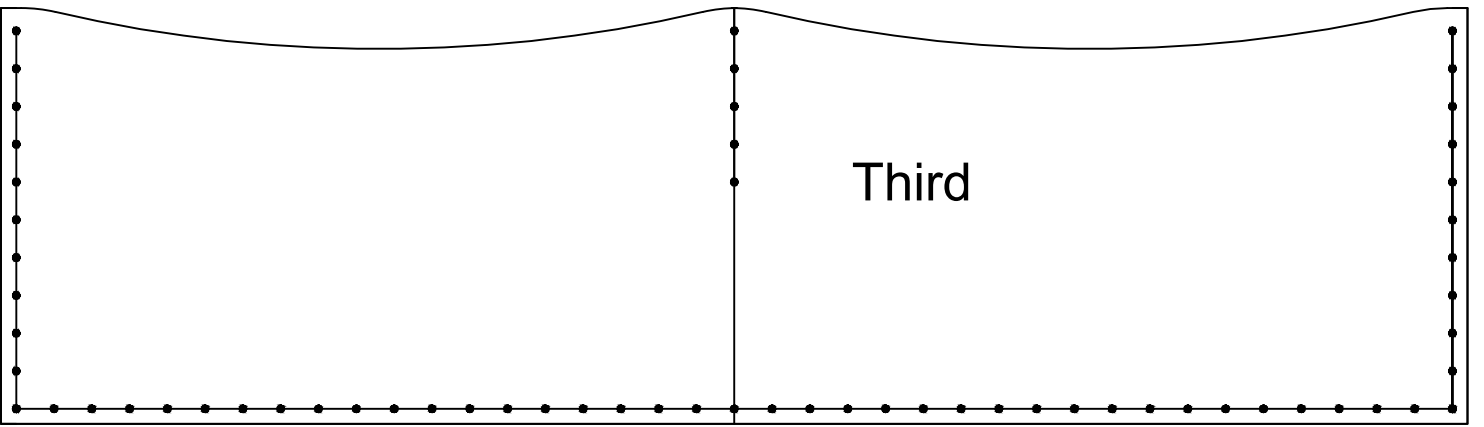
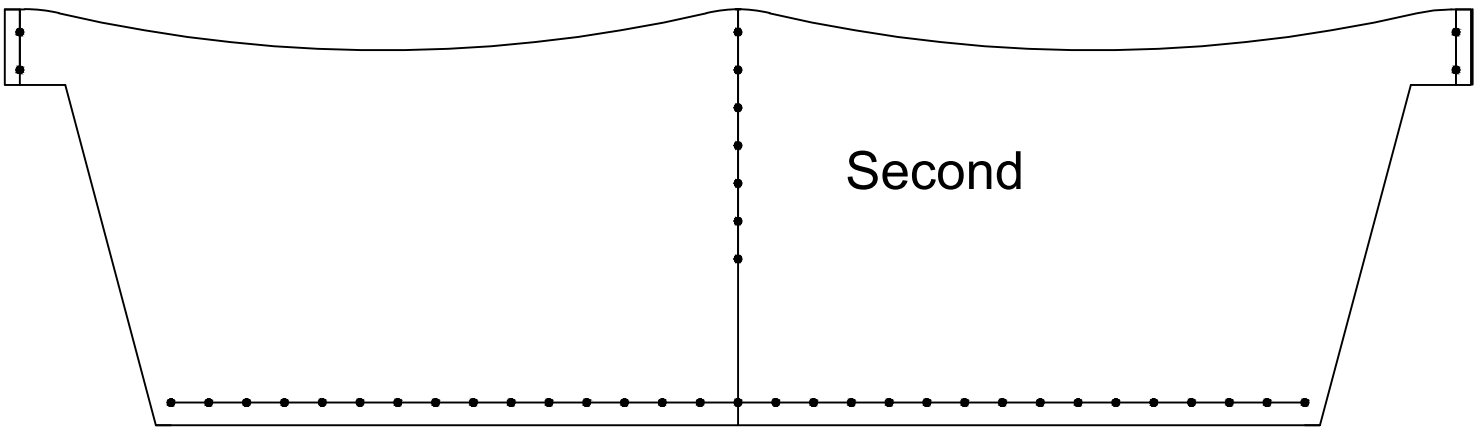
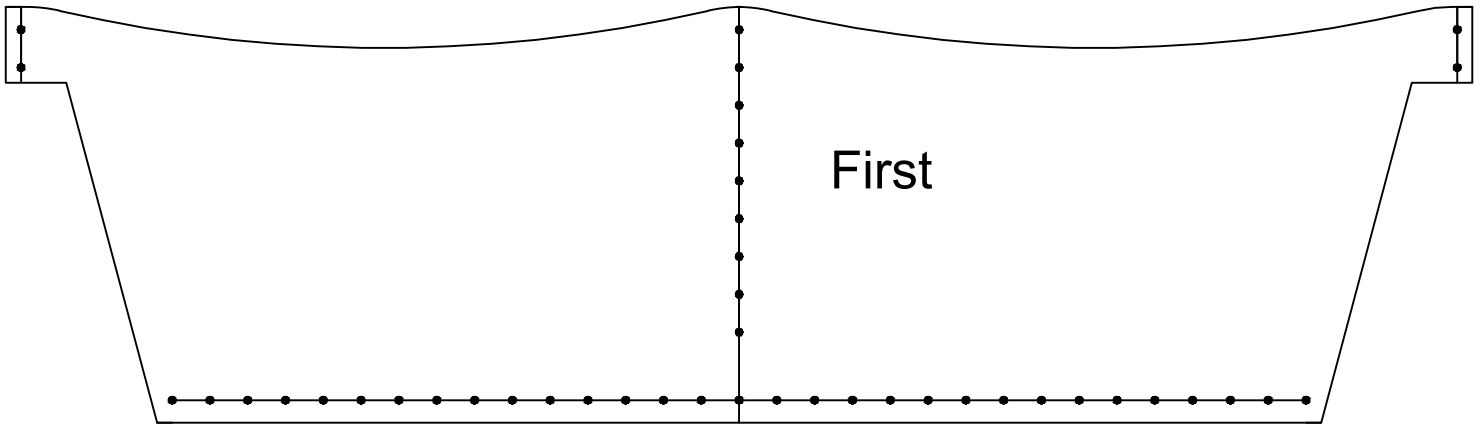

Test scale, 80mm

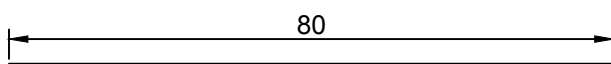
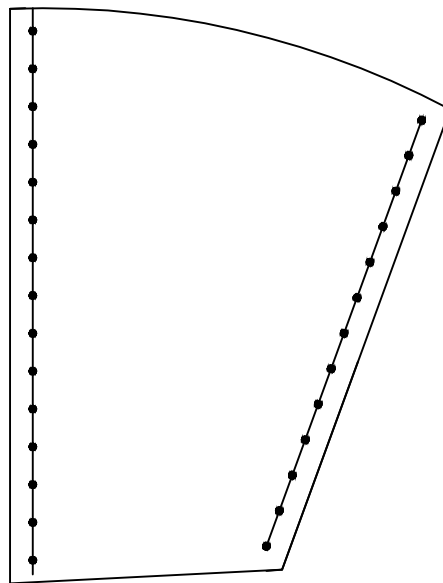
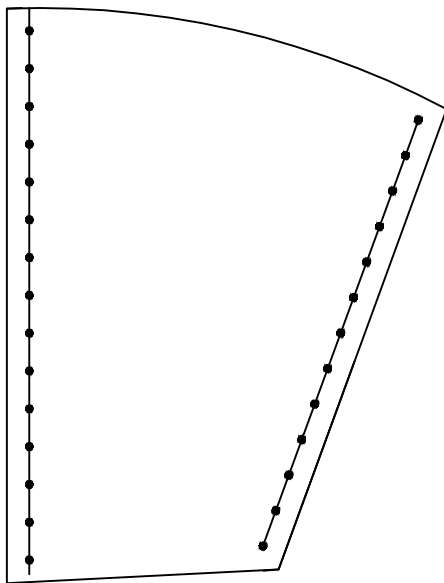
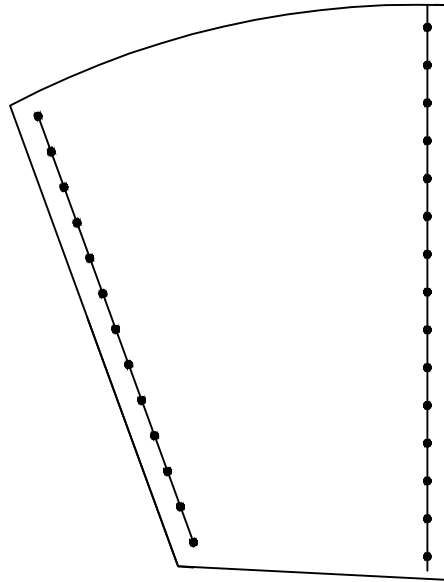
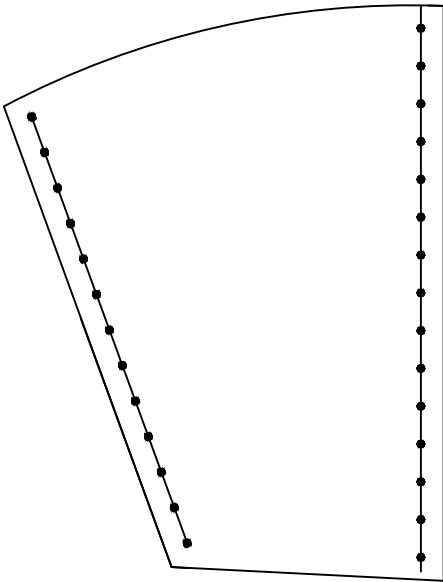
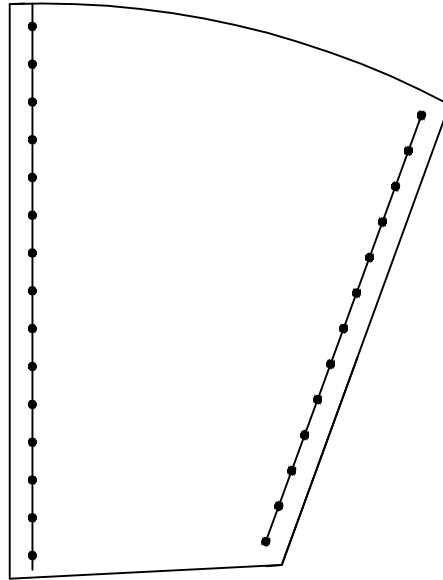
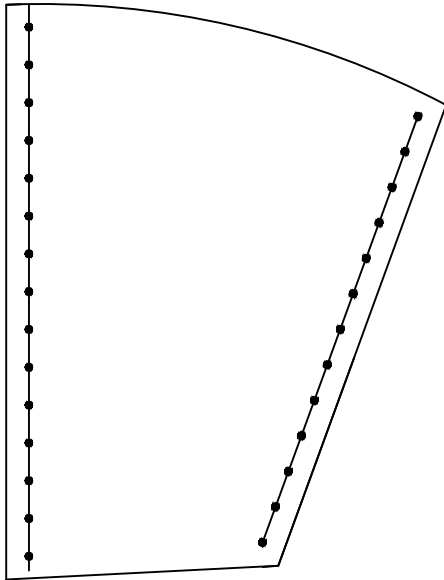

Test scale, 80mm

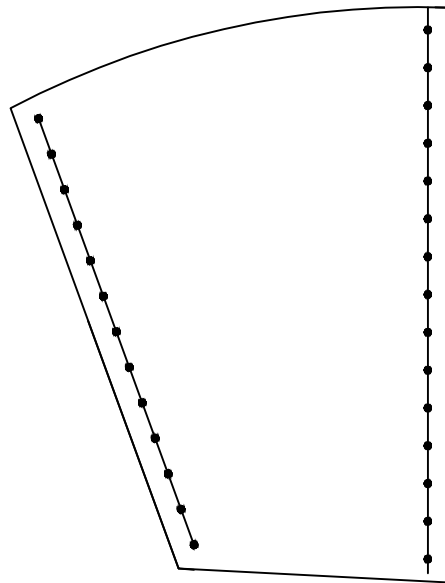
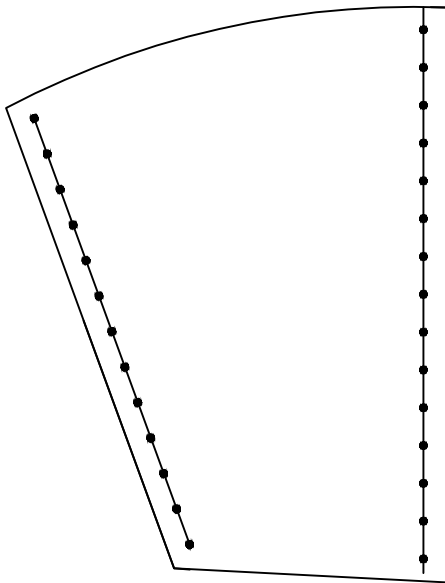
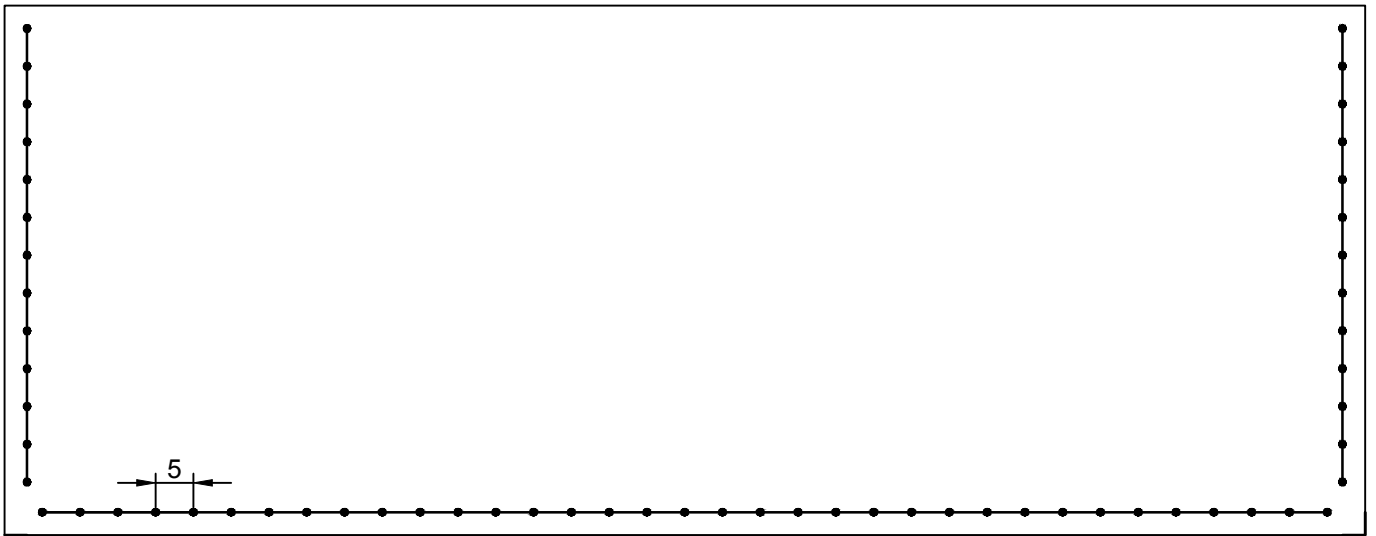
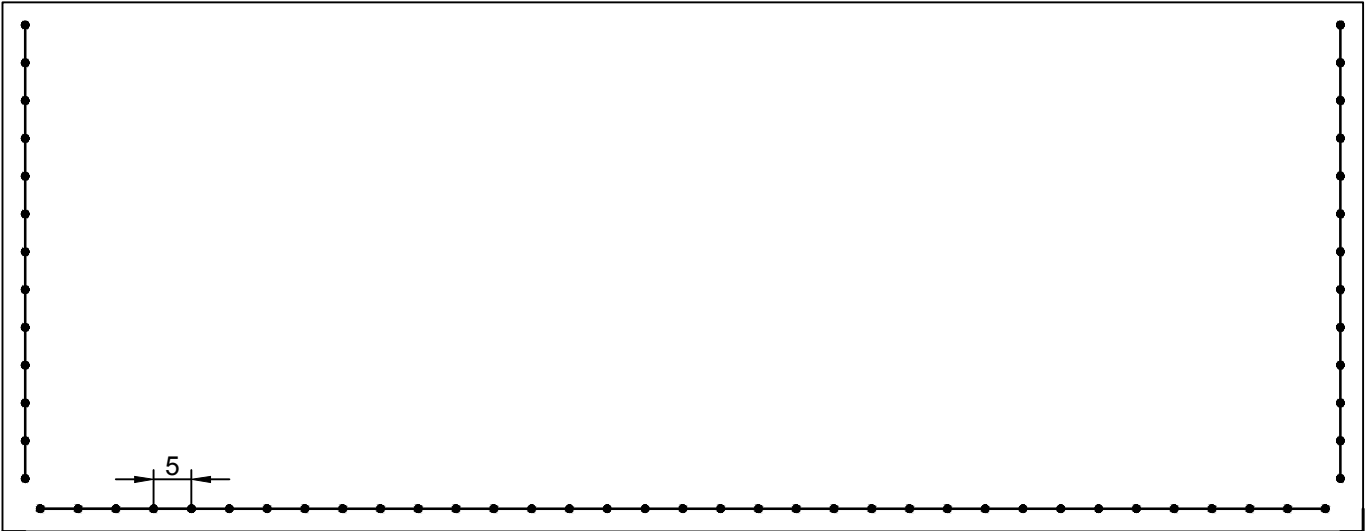

80

Test scale, 80mm

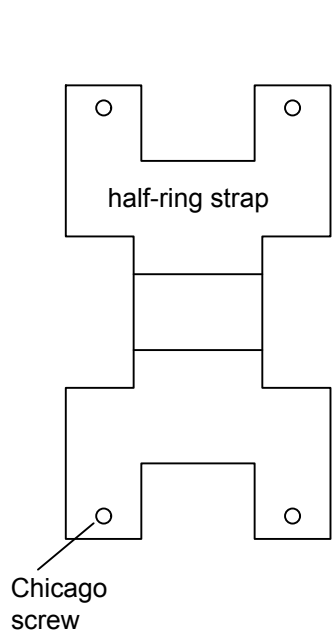

Chicago screw

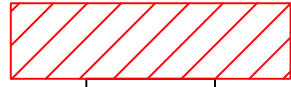
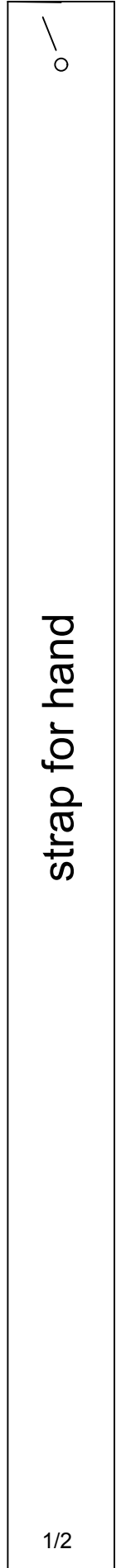

2/2

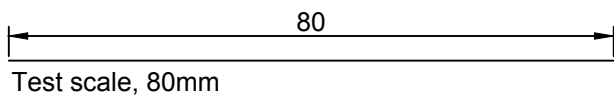
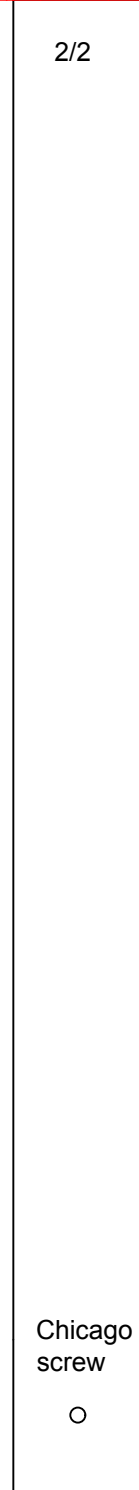

1/2

