

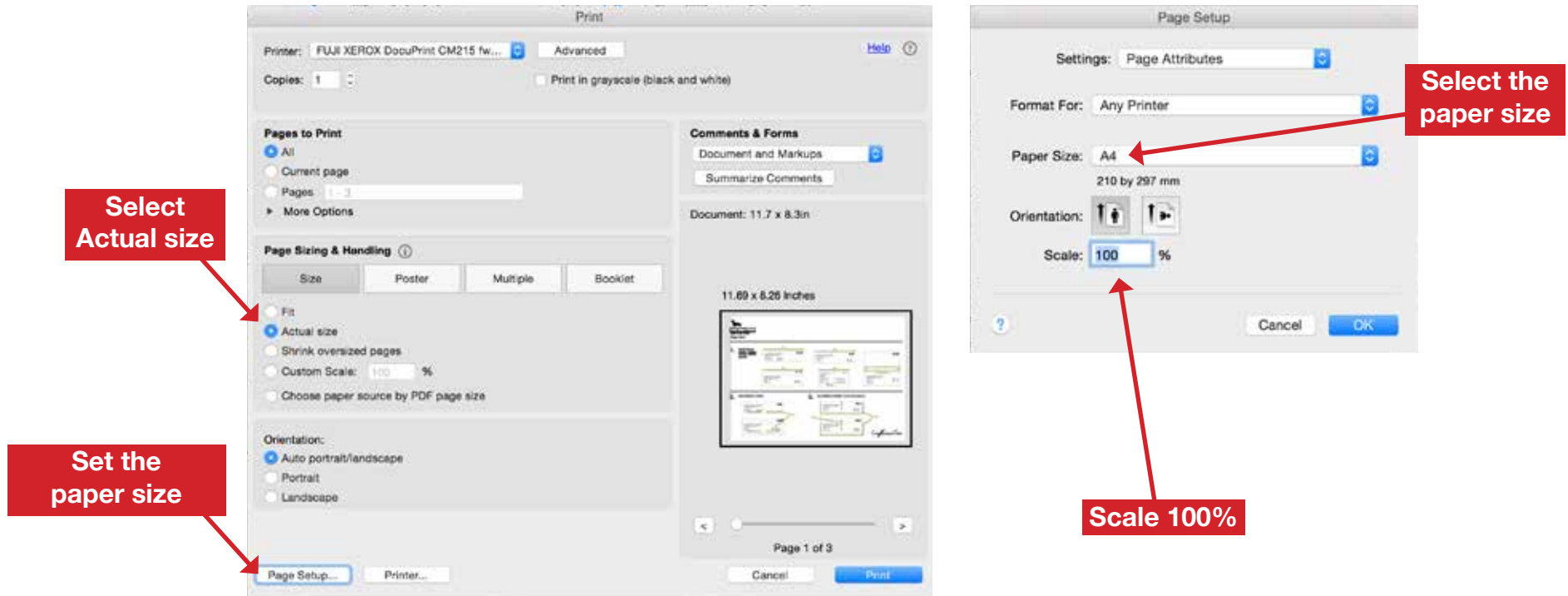

## PRINTING INSTRUCTION

1. File > Print
2. Click on “Page Setup” button make sure your paper size is set to the paper size that you will print and Scale at 100%
3. In “Pages Sizing & Handling” click on “Size” button and select “Actual size”



### IMPORTANT NOTE:

- **ADOBE ACROBAT READER (FREE SOFTWARE)** is recommended to open and print the patterns

link for free download

<https://get.adobe.com/reader>

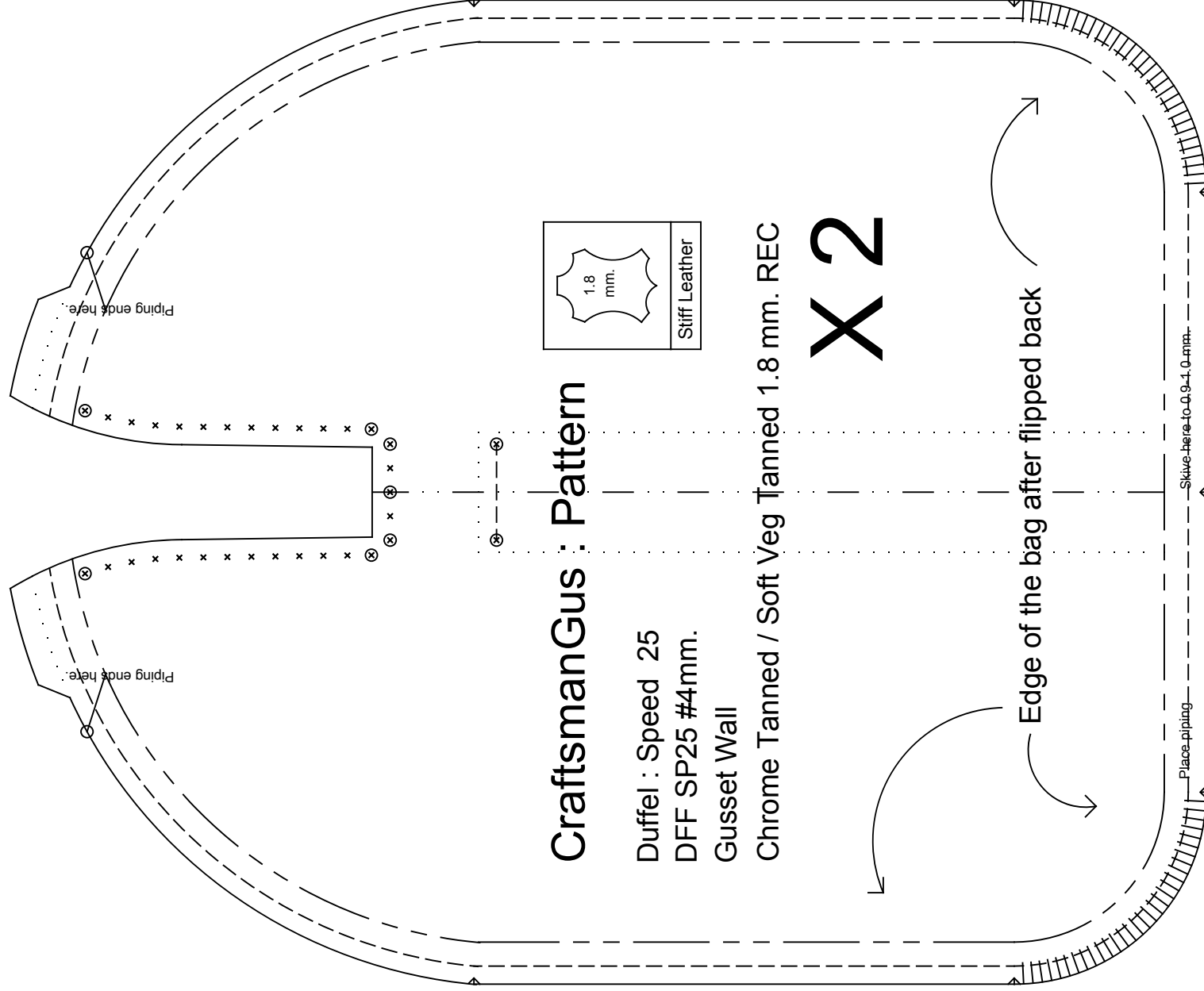
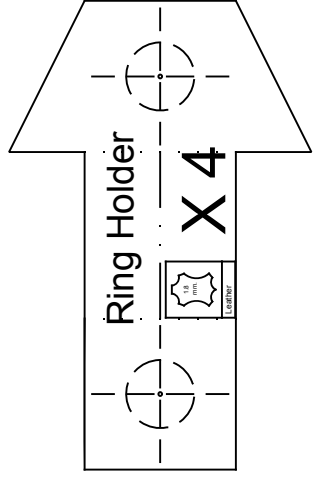

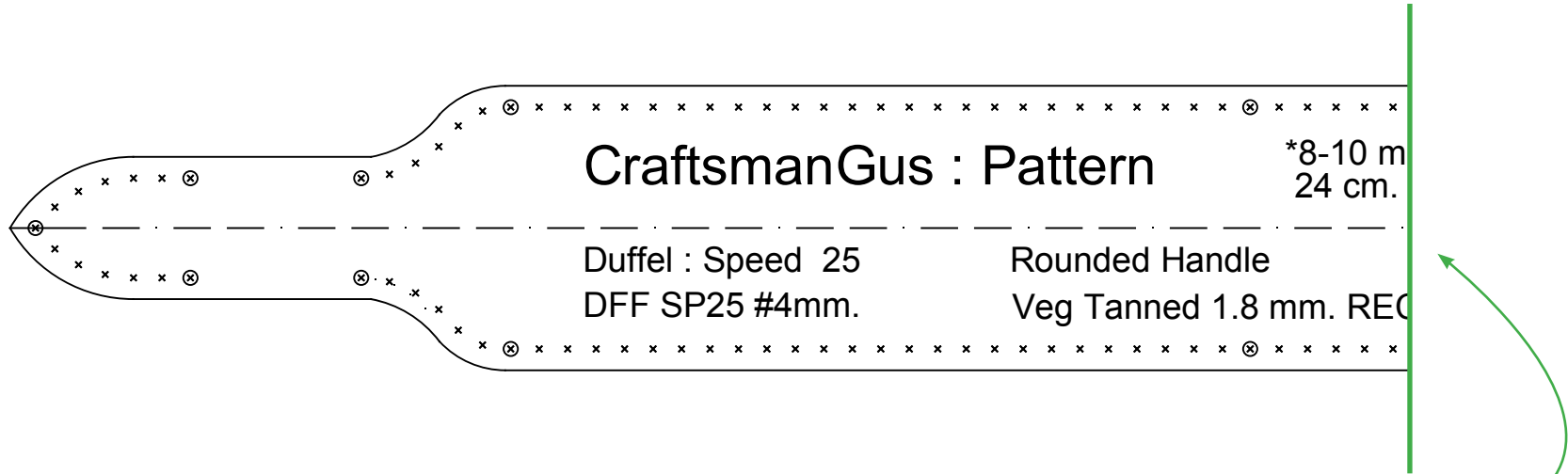

Connect

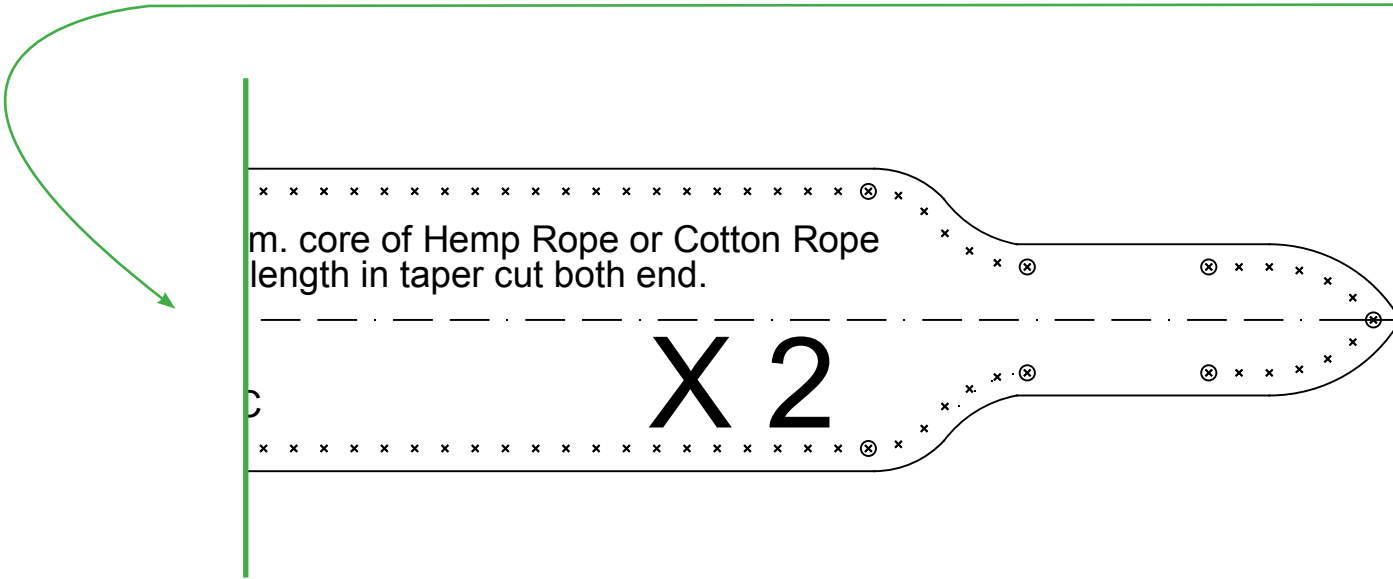

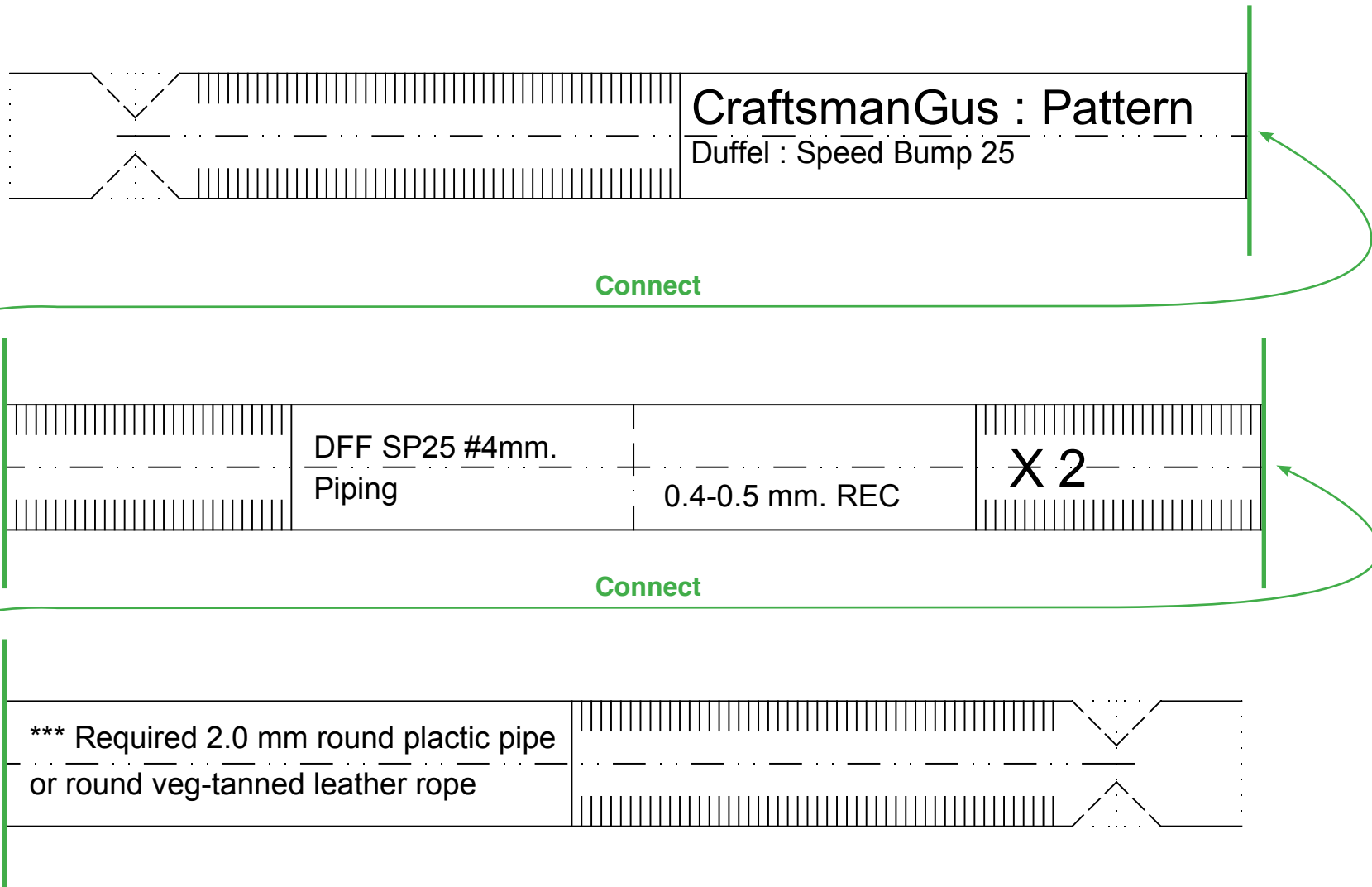

Width: 59.5 cm.  
Height: 2 cm.



Speed 25

Page 4 of 15

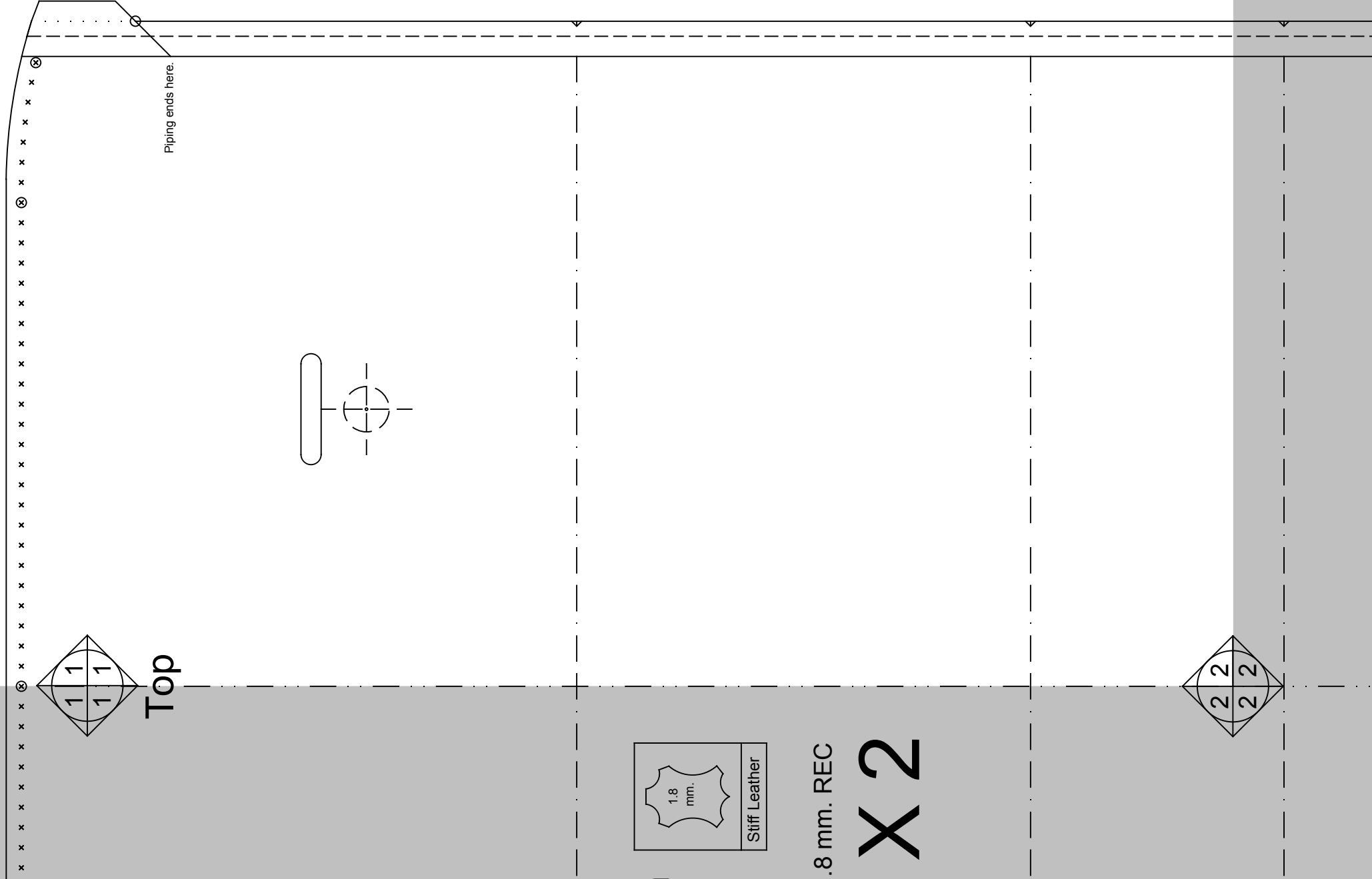

Piping ends here.

Top

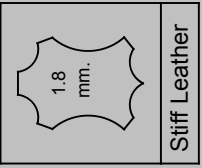

.8 mm. REC

X 2

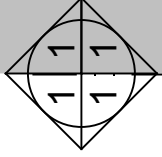

Top

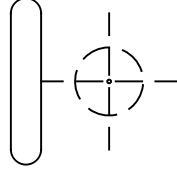

## CraftsmanGus : Pattern

Duffel : Speed 25  
DFF SP25 #4mm.

Main Body

Chrome Tanned / Soft Veg Tanned 1.8 mm. REC

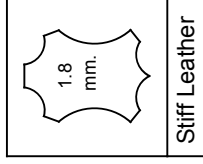

# X 2



Piping ends here.

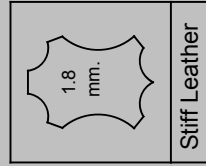
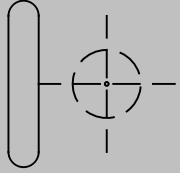

.8 mm. REC

**X 2**



Bottom

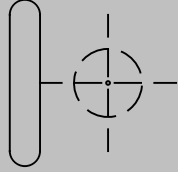

## CraftsmanGus : Pattern

Duffel : Speed 25

DFF SP25 #4mm.

Main Body

Chrome Tanned / Soft Veg Tanned 1.8 mm. REC

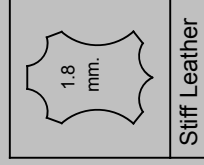

# X 2



Bottom



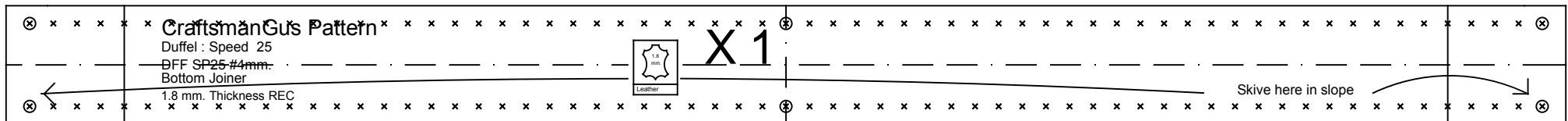
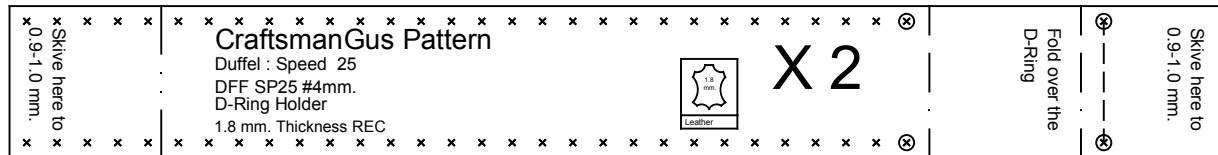
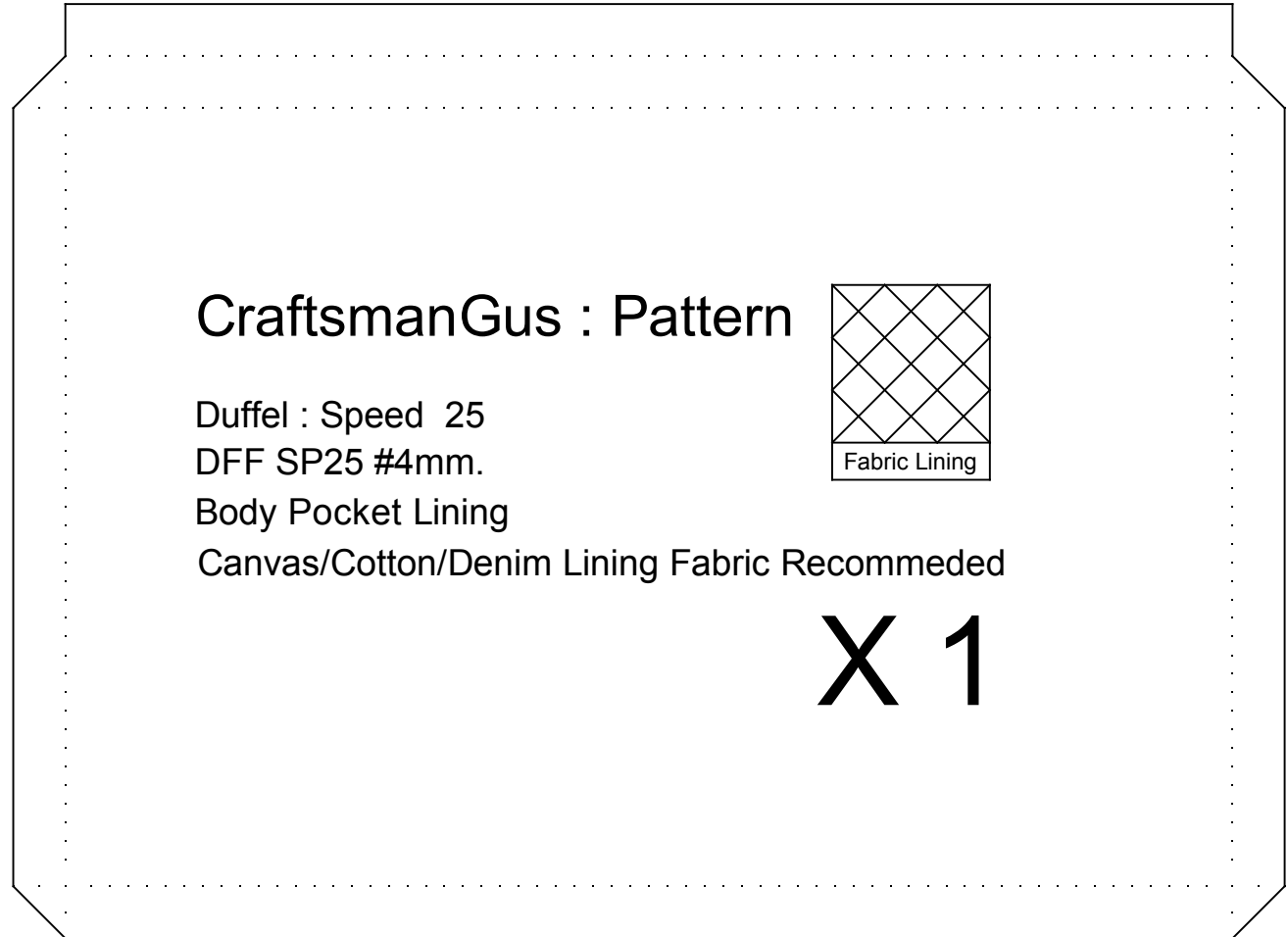



## CraftsmanGus : Pattern

Duffel : Speed 25

DFF SP25 #4mm.

Bottom Lining

Canvas/Cotton/Denim Lining Fabric Recommeded



**X 1**

# CraftsmanGus : Pattern

Duffel : Speed 25

DFE SP25 #4mm.

Body Pocket Lining

Canvas/Cotton/Denim Lining Fabric Recommended

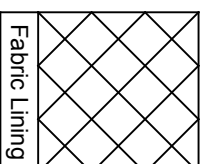

# X 1

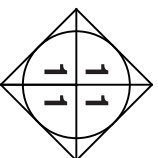

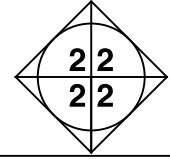
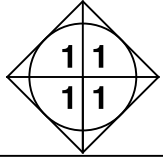

Place D-Ring here if needed (pattern not included)

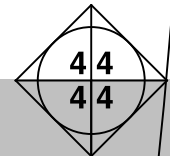
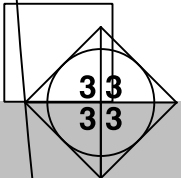
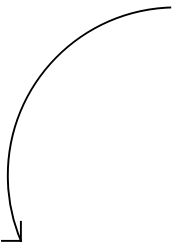

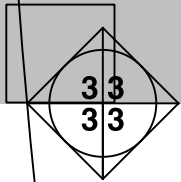

Speed 25  
Page 12 of 15

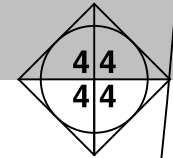

Zipper No.05 (Asia) or No.06 (Swiss Zipper brand) 40cm Approx.

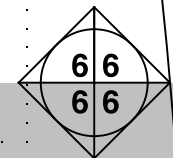
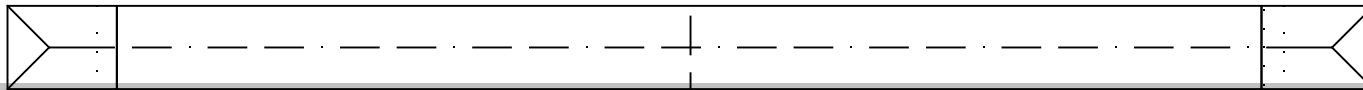
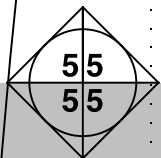

Zipper No.03 (Asia) or No.04 (Swiss Zipper brand) 10 cm Approx.

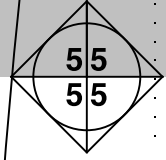

## CraftsmanGus : Pattern

Duffel : Speed 25

DFP SP25 #4mm.

Body Lining

Canvas/Cotton/Denim Lining Fabric Recommended

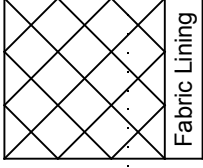

Fabric Lining

# X 1

Zipper No.03 (Asia) or No.04 (Swiss Zipper brand) 18 cm. Approx

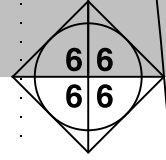
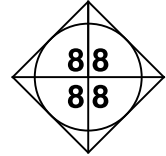
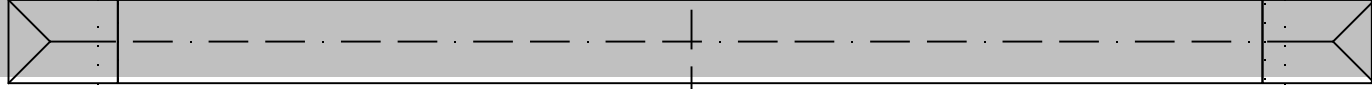

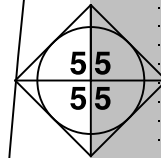
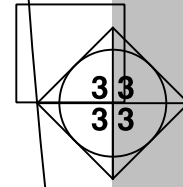
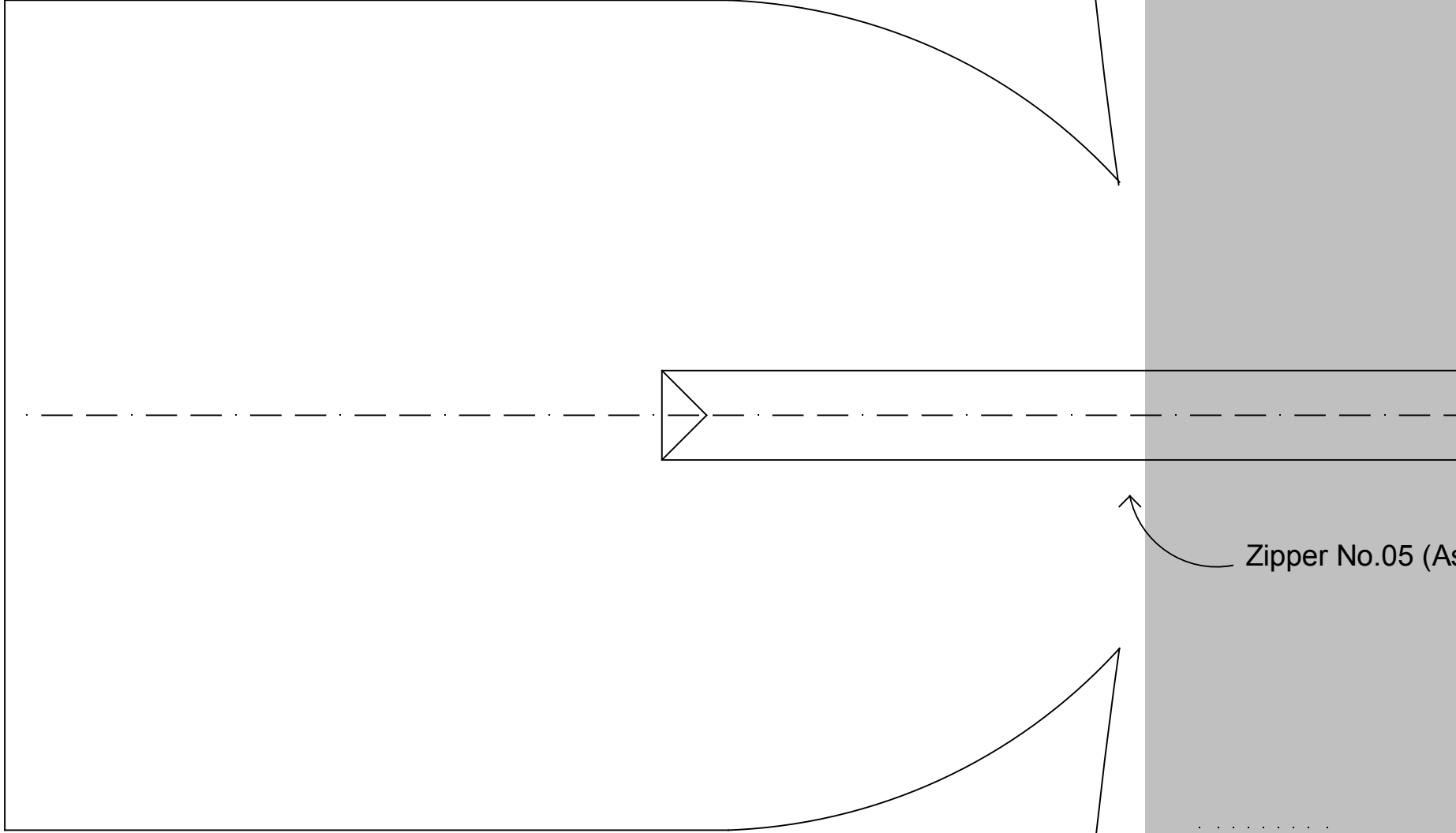
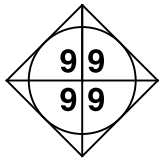
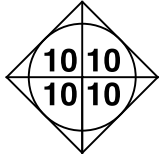

Zipper No.05 (A)



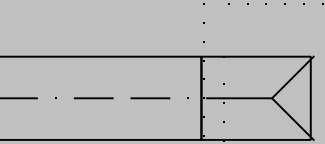
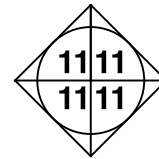
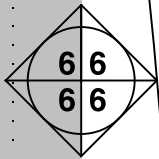
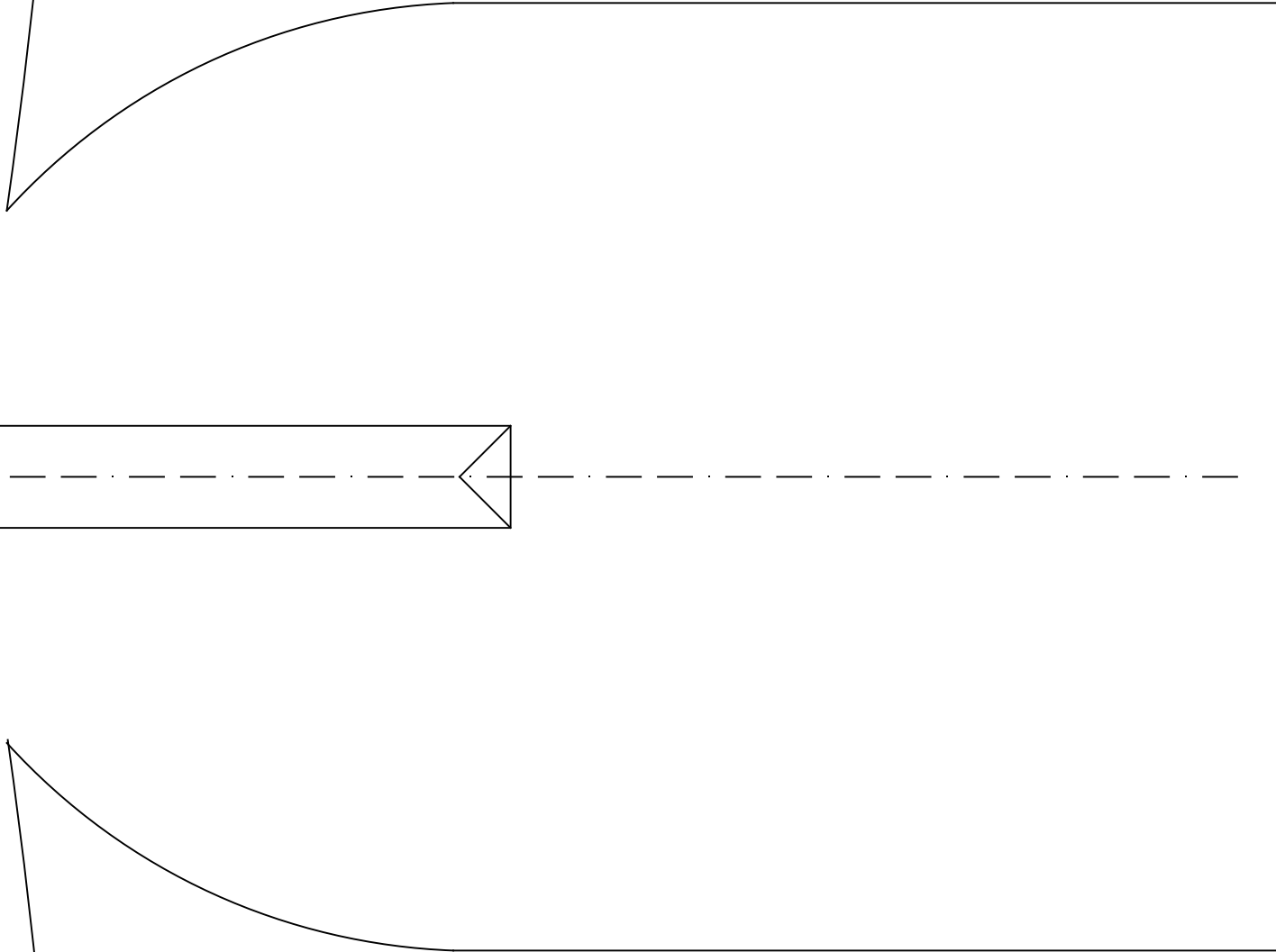
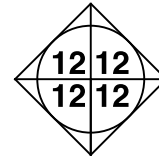
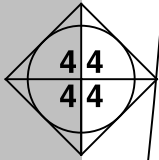

and) 18 cm. Approx