

Hello :)
My name is Behlül.



Thank you for purchasing the product.

I tried to make the product error free. I have prepared a Youtube video for your convenience.

Check the dimensions first.

For the holes you need 1mm punches. Be careful before cutting. For more precise cuts I recommend a sharp blade and oblique grip.

The calfskin I use is 1.7 mm soft. You can use thicker or thinner leather. (like enlarging or shrinking).

Do not rush the cutting process.

I hope you like crafting.

My English is not very good so I use google I hope I translated what I wrote correctly. Let me know if you have any questions, I may be delayed due to the time difference.

I need to sell more to stay afloat in this business. I need your stars and comments so others can buy my products.

do it fondly, use it fondly :)

I work on demand. If there is a model you can't find the drawing of or if you have an idea, I can draw it for you. You can share your ideas.

For the thread measure, up to four layers of thread are used from the place to be sewn. Beginners should keep this size tall.

The zipper thickness I use is 32mm. I used to draw zipper holes on my products, but I couldn't because the zipper is oval in this bag model. If you do it as in the video, it's fine.

Make it with love, use it with love.

You do not need to print this page.

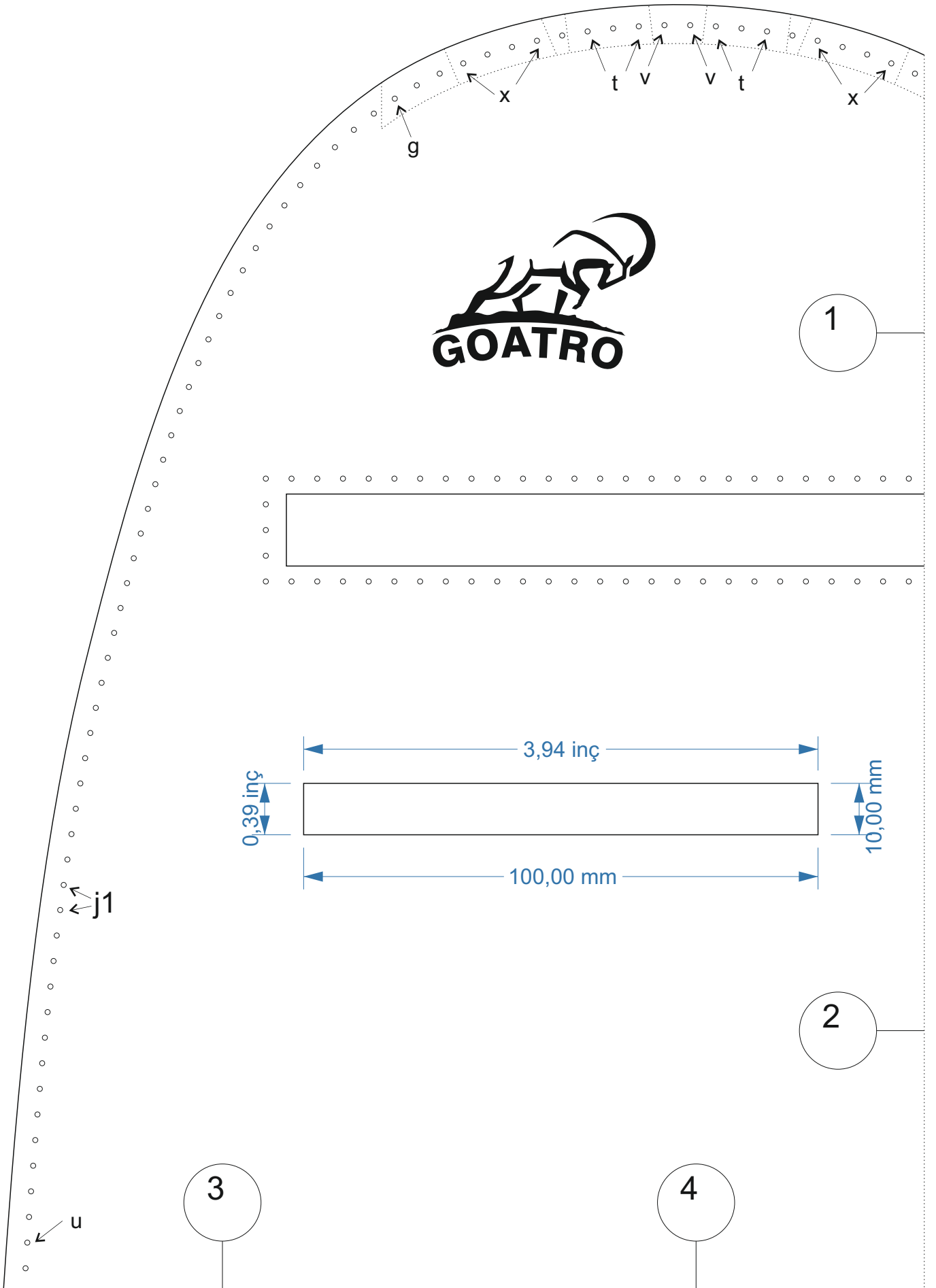

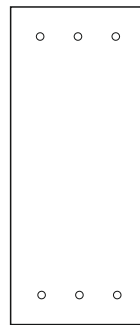
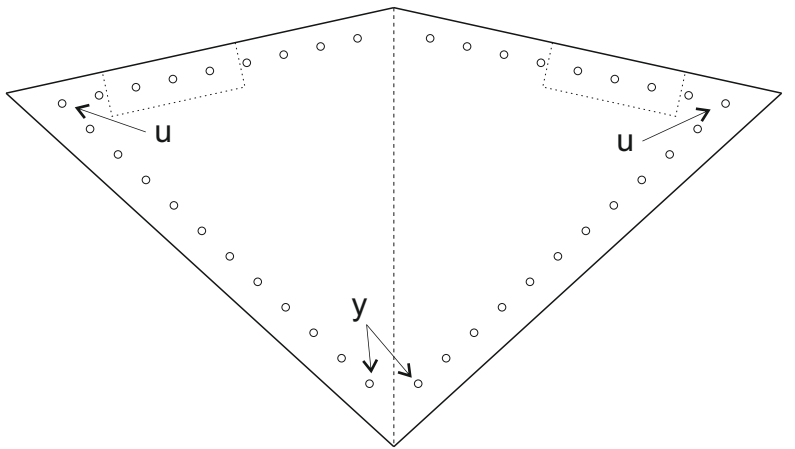
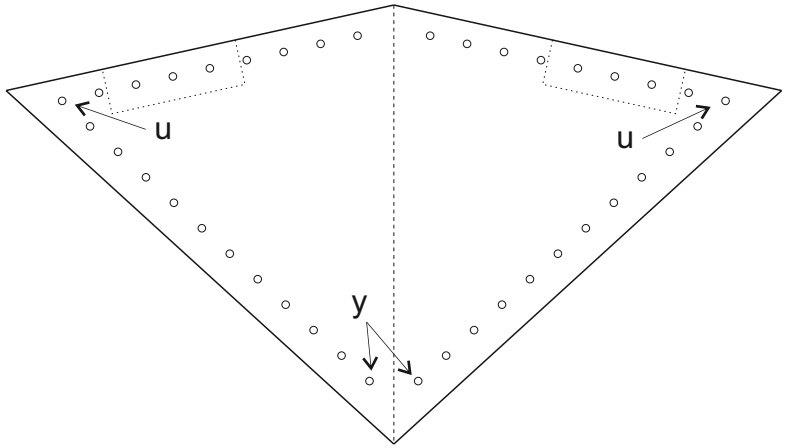
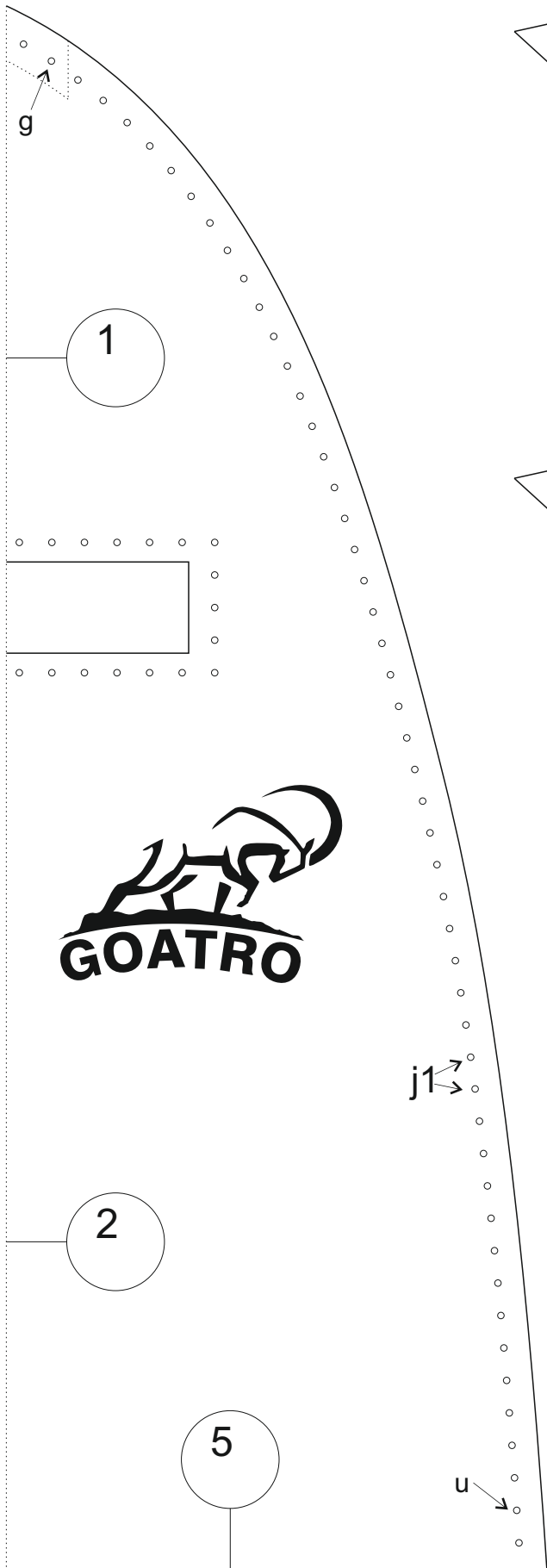

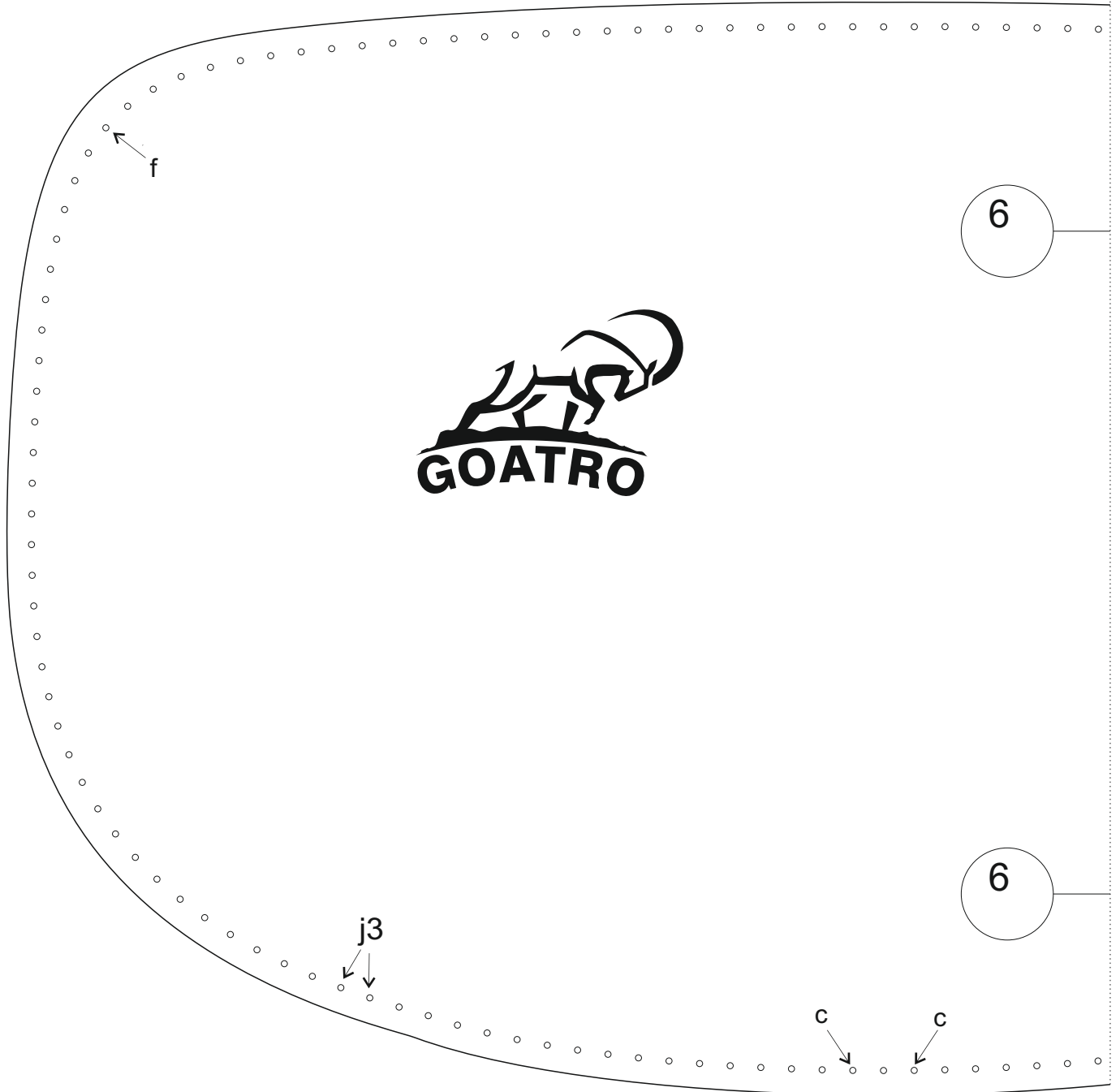
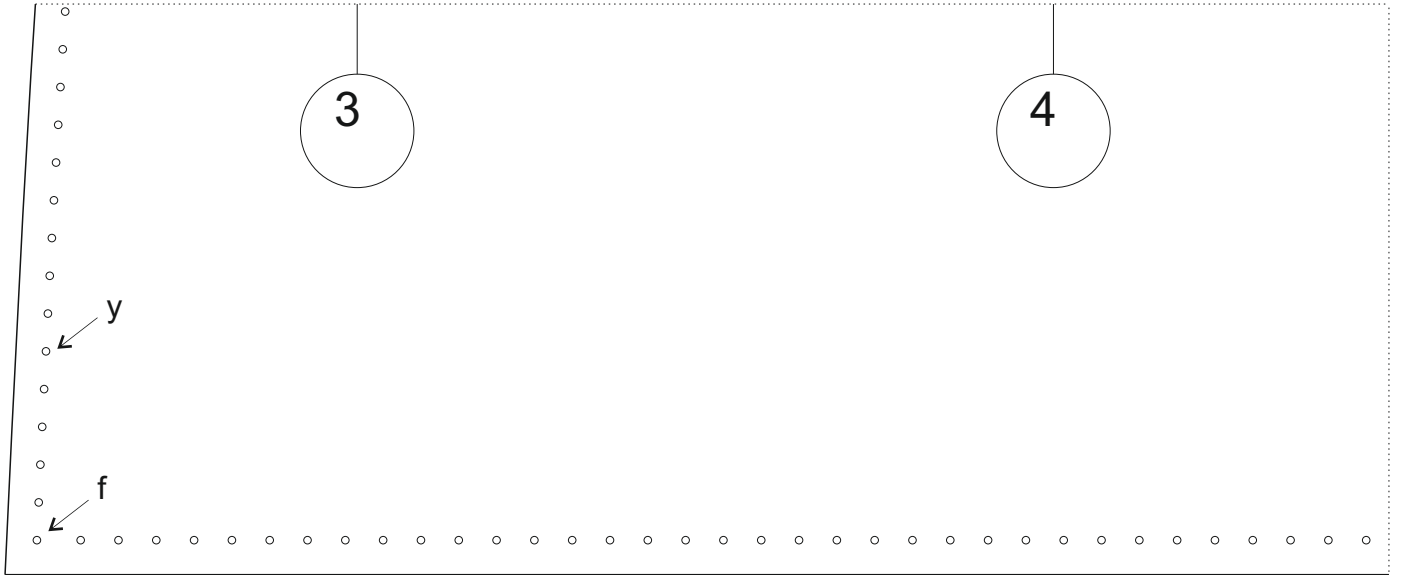

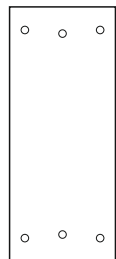
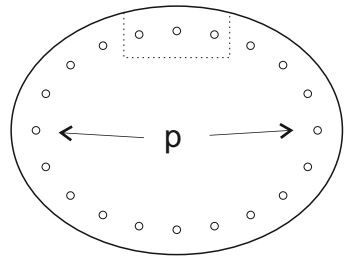
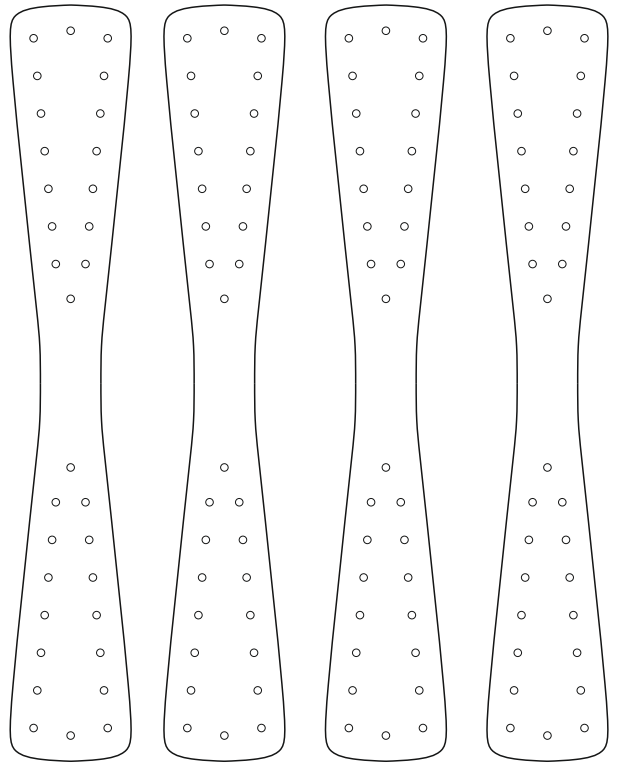
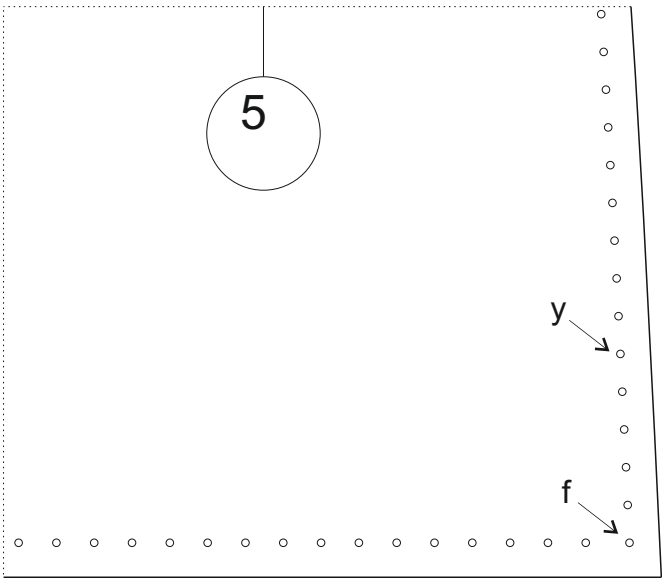

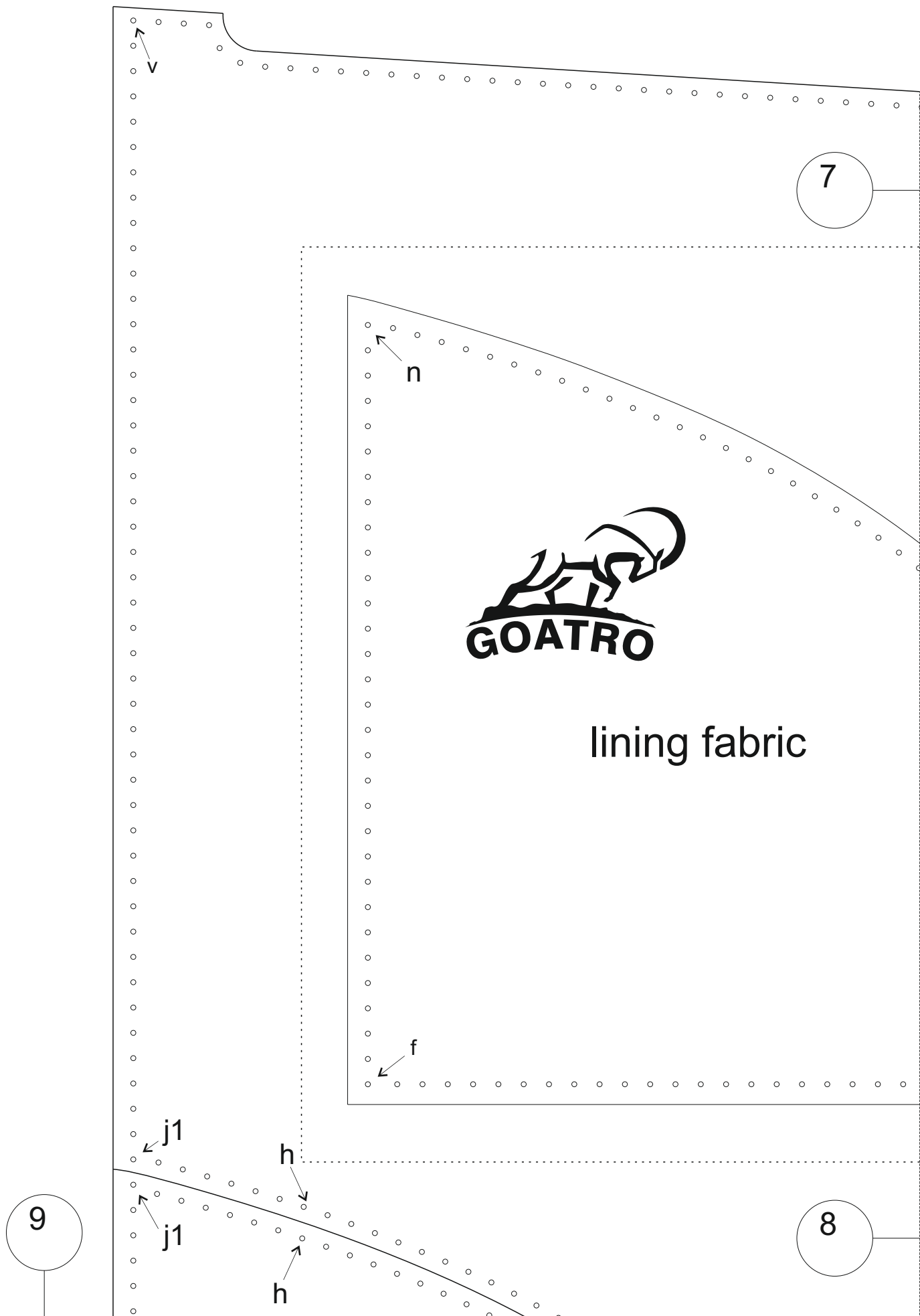

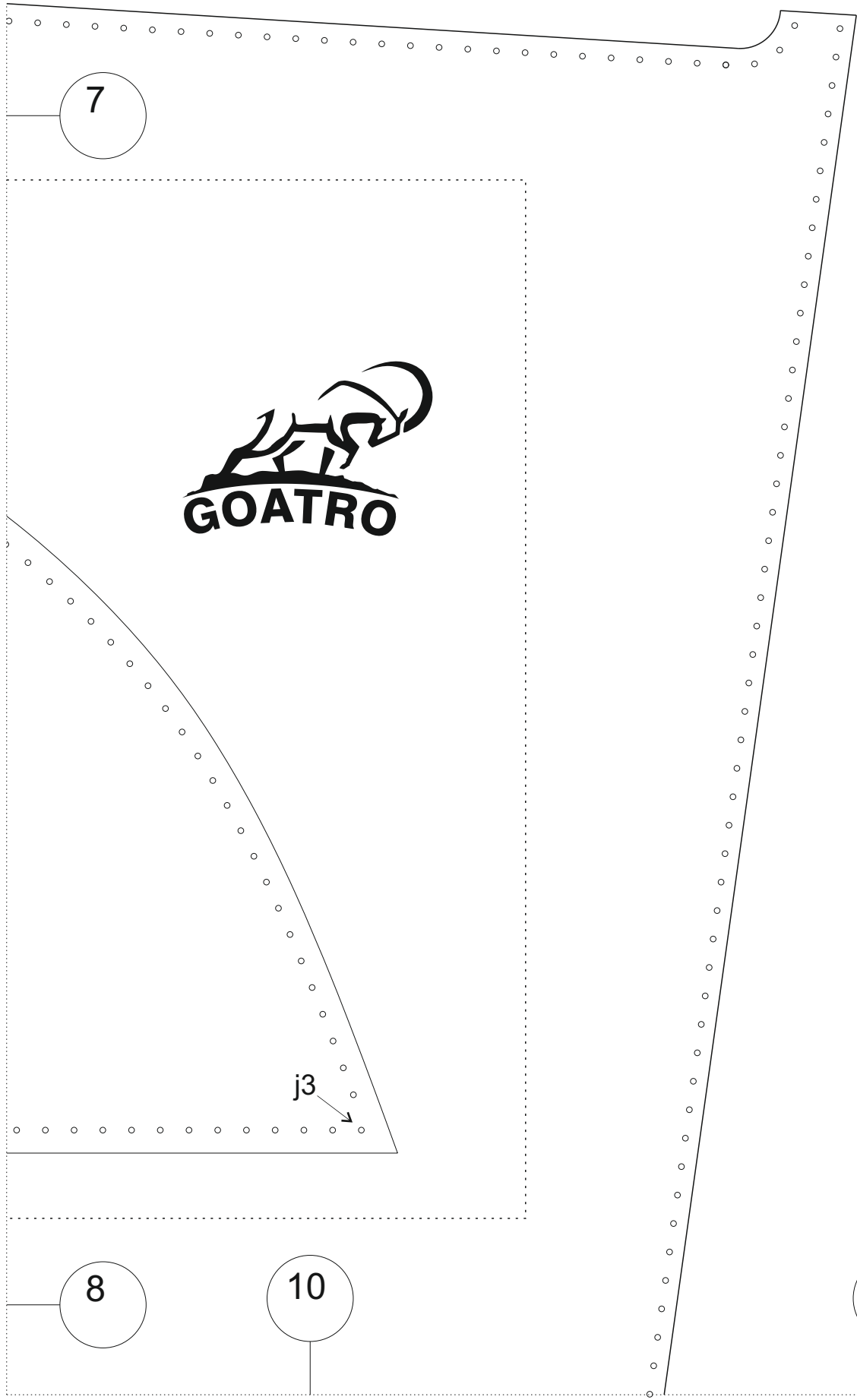

7

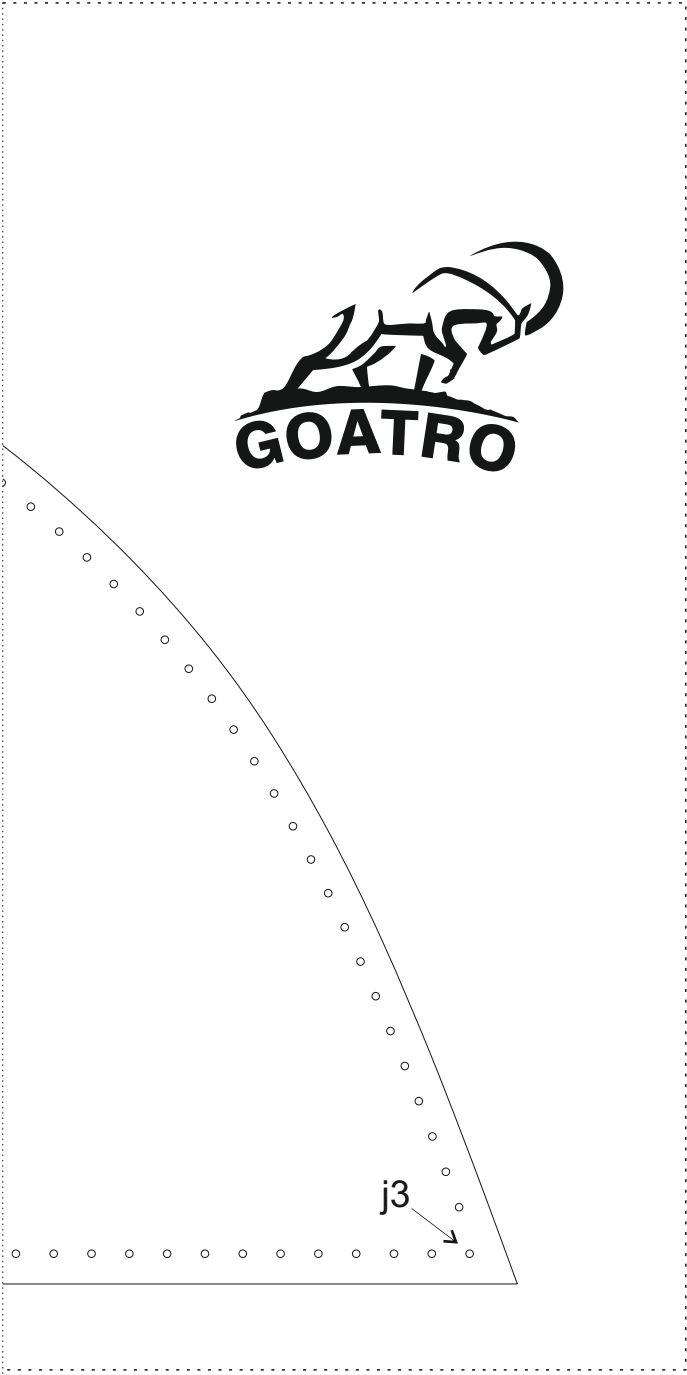

8

10

11

9

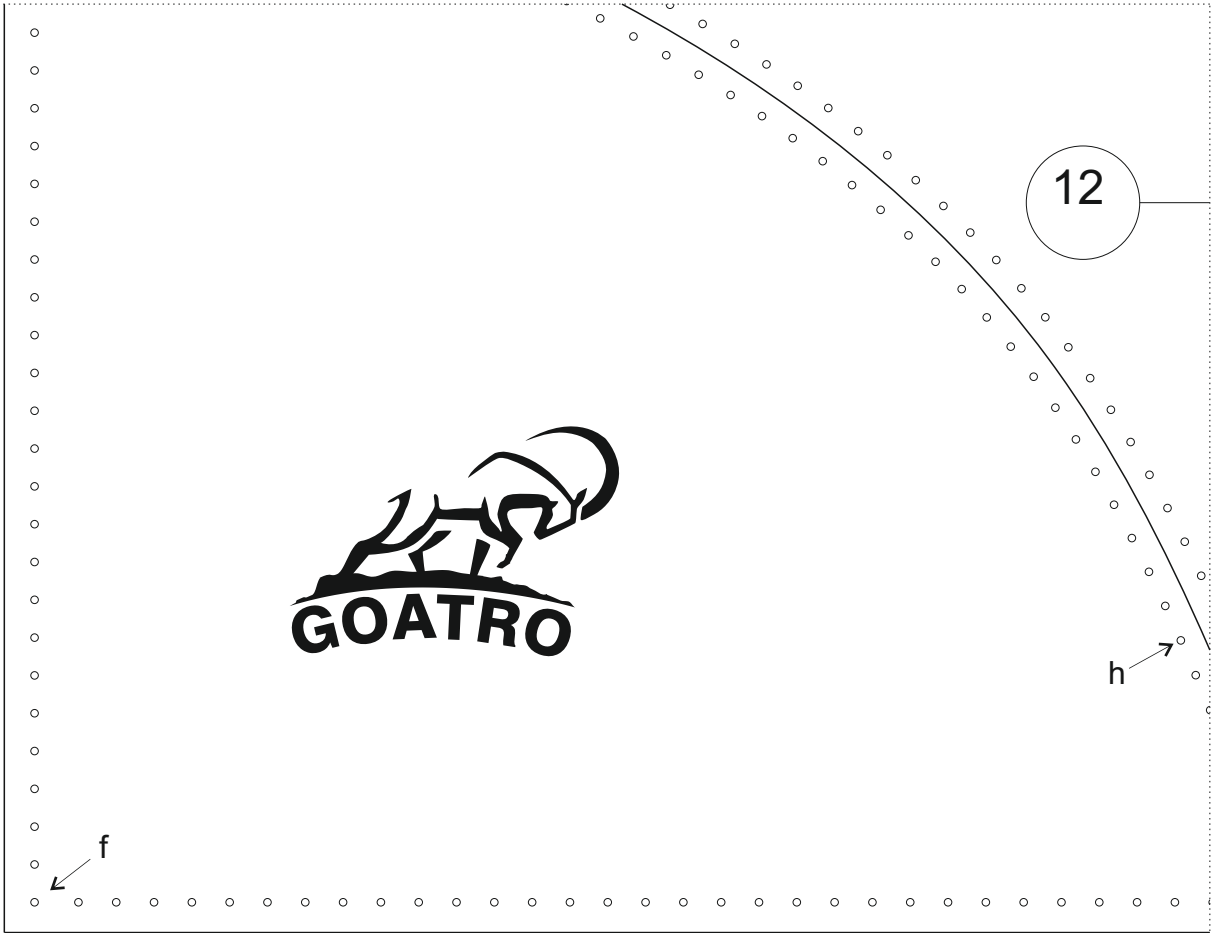

12

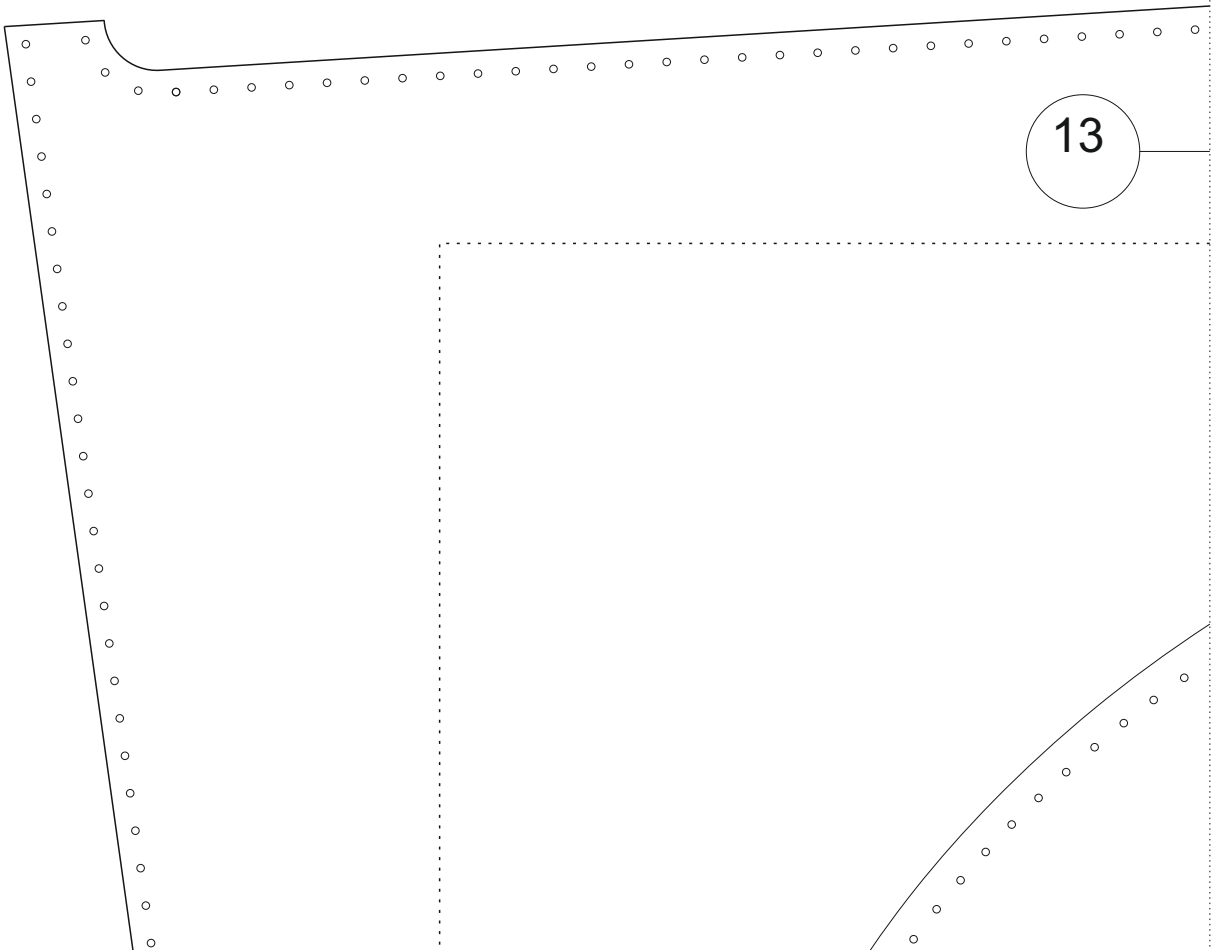

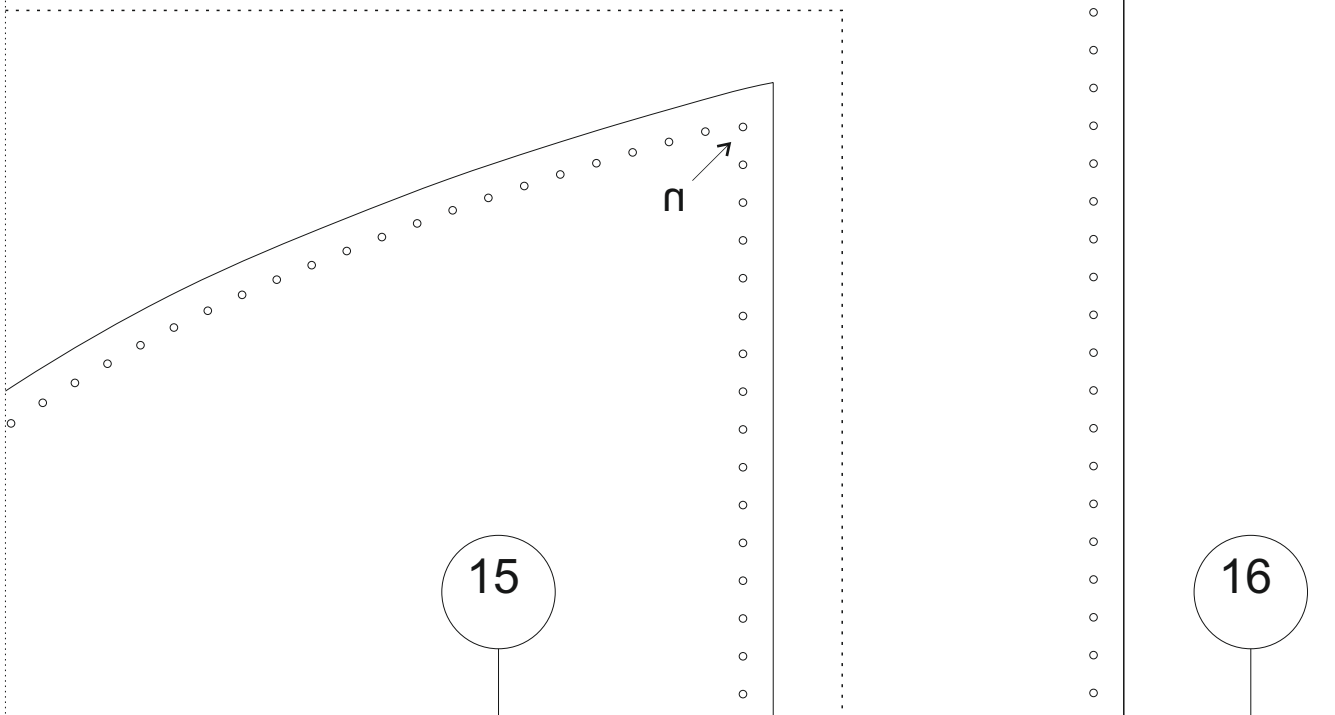
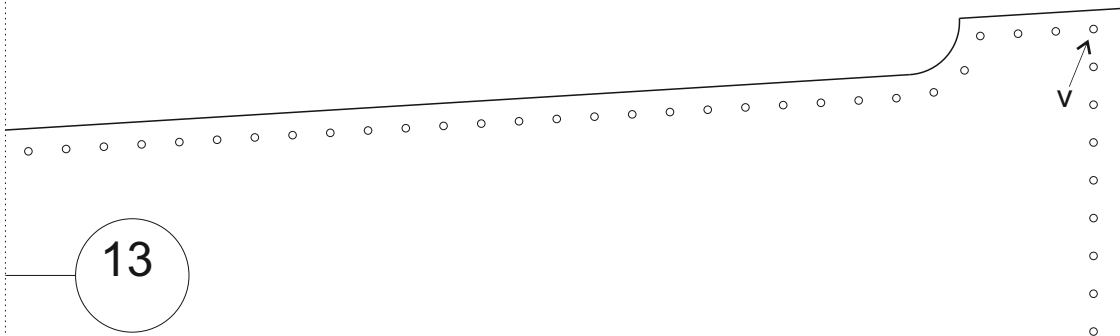
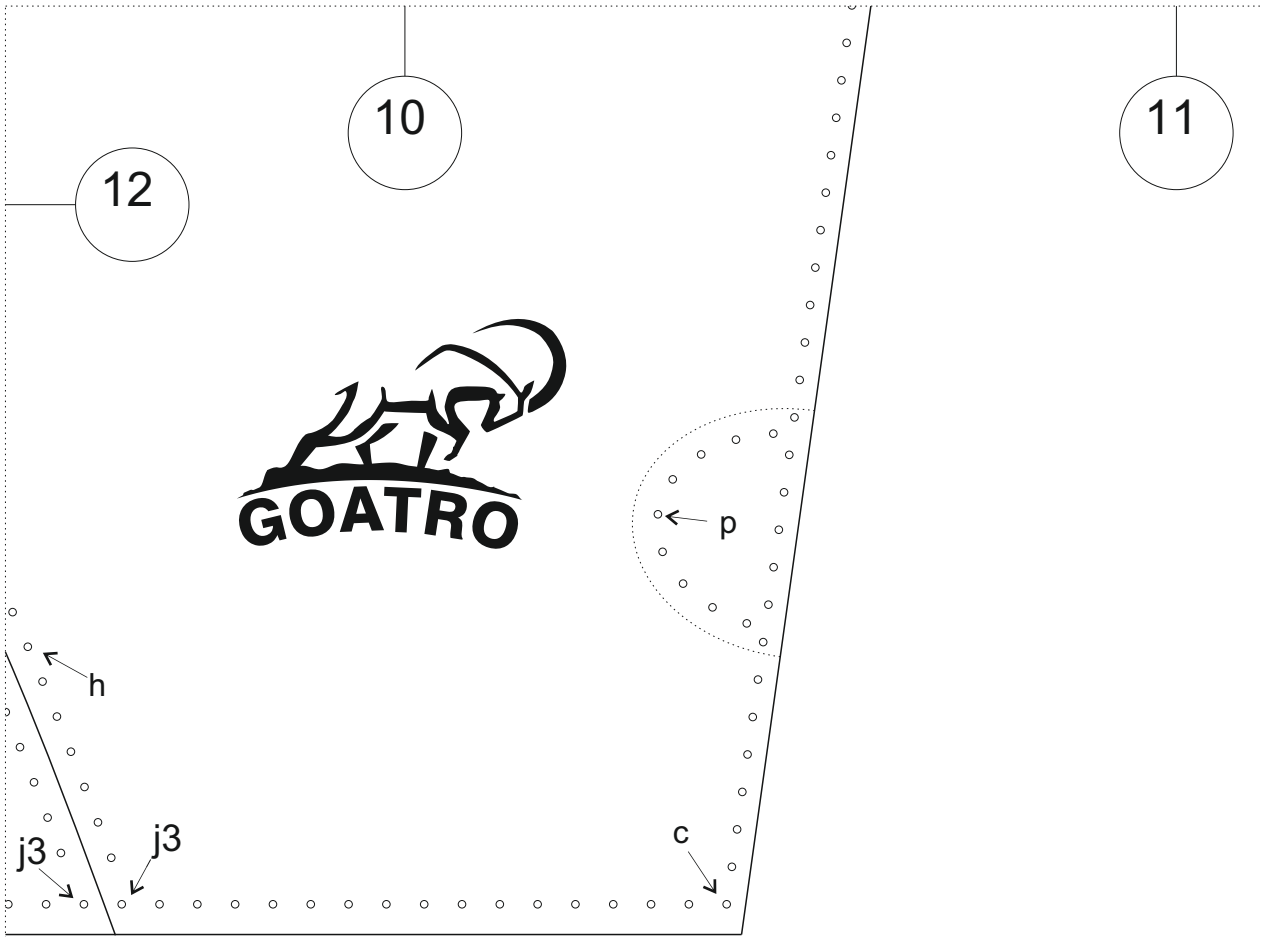

14

13

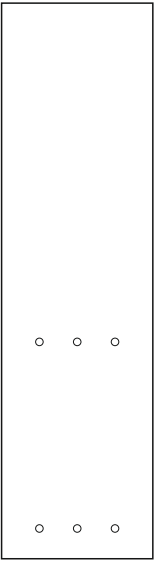
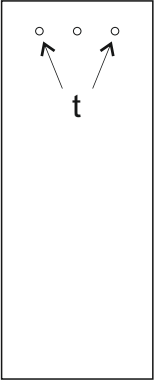

I used 100 cm * 2 cm leather for the bag handles.

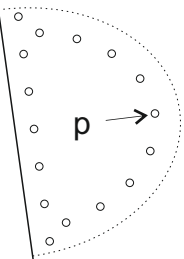

c

j4

j4

h

j4

h

13

lining fabric

15

16

13

f

j2

h

j2

h



f

13

